

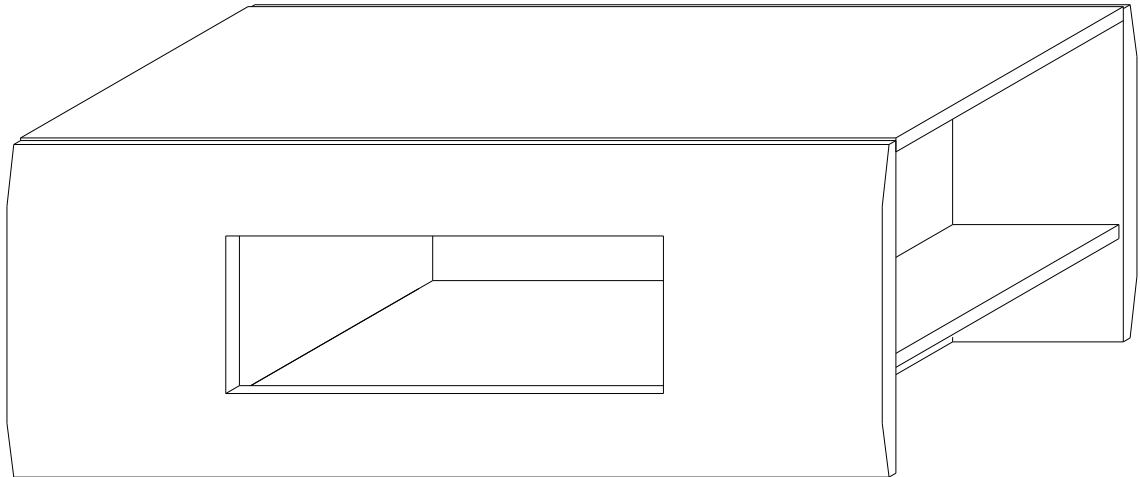

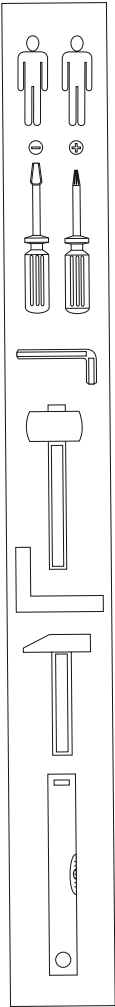

CLIF CT

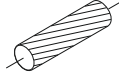
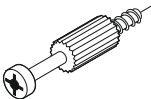
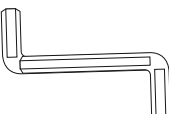

1	 8x35	<u>X 24</u>	2		<u>X 20</u>
26		<u>X 1</u>	9		<u>X 20</u>
10A		<u>X 4</u>	9A		<u>X 20</u>

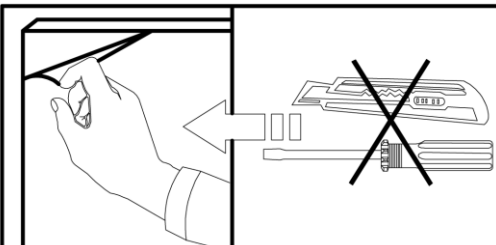
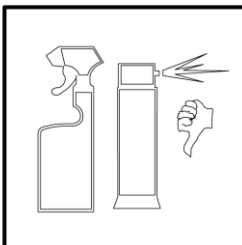
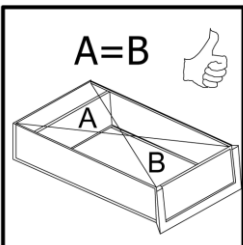
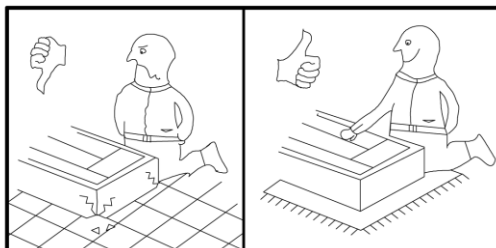
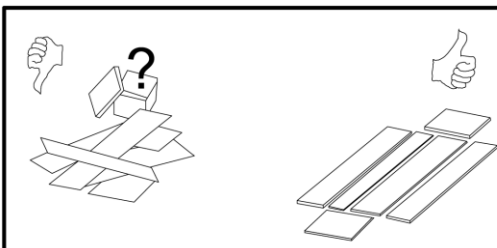
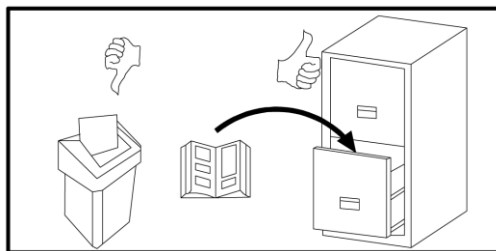
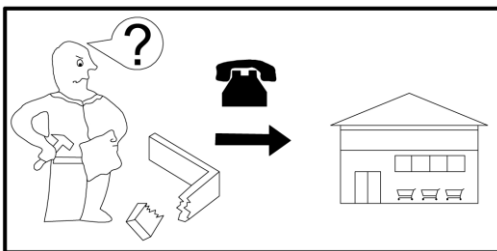

I

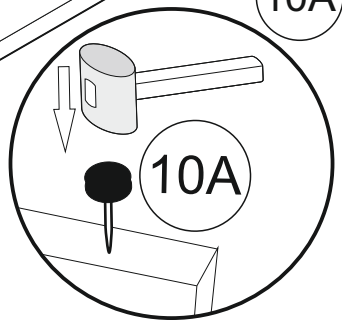
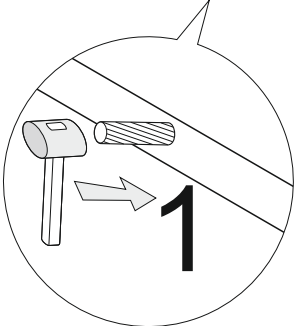
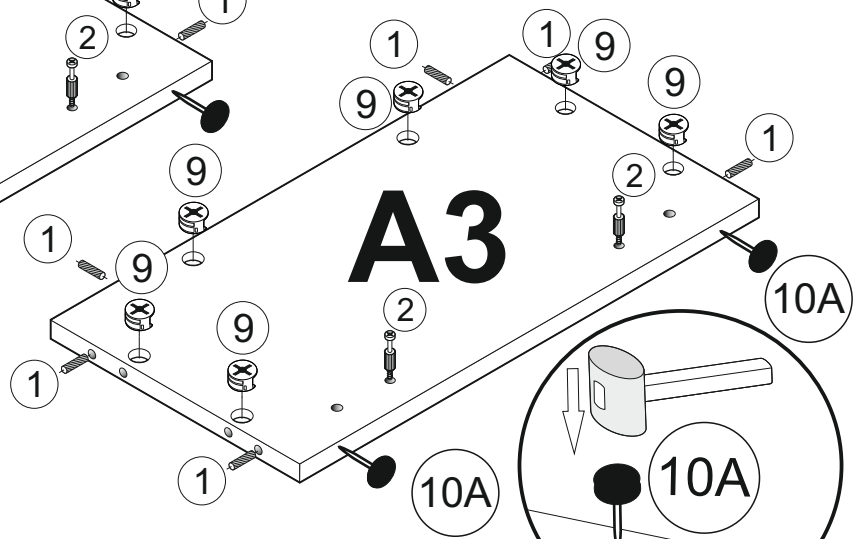
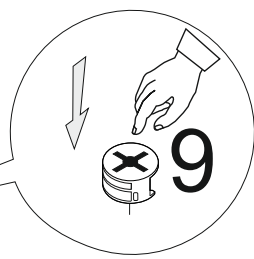
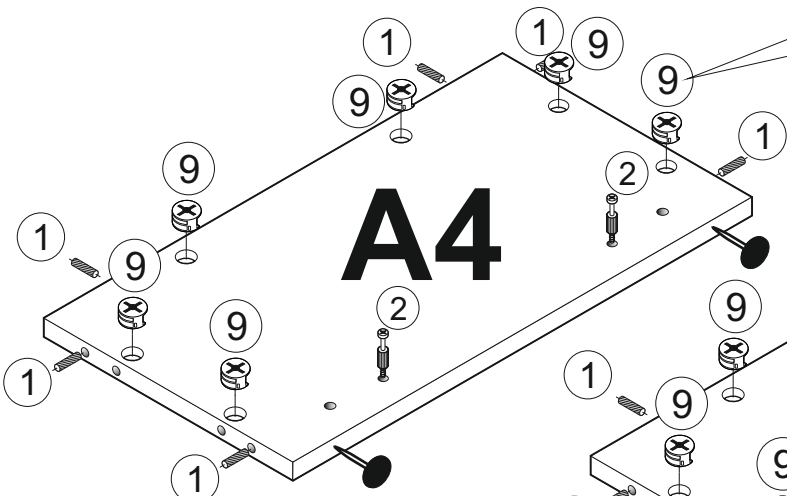
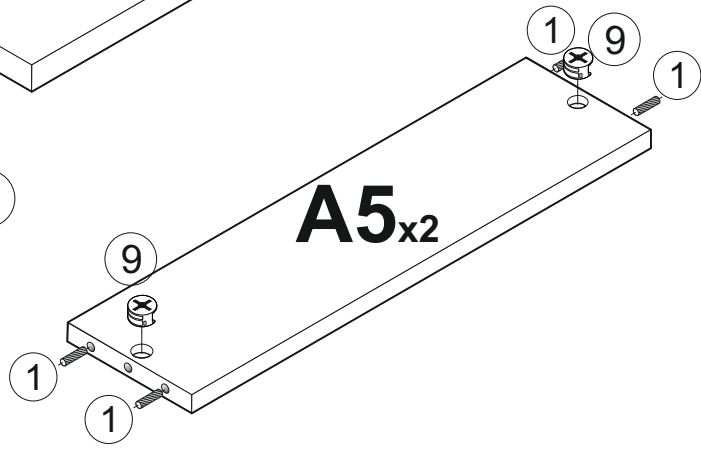
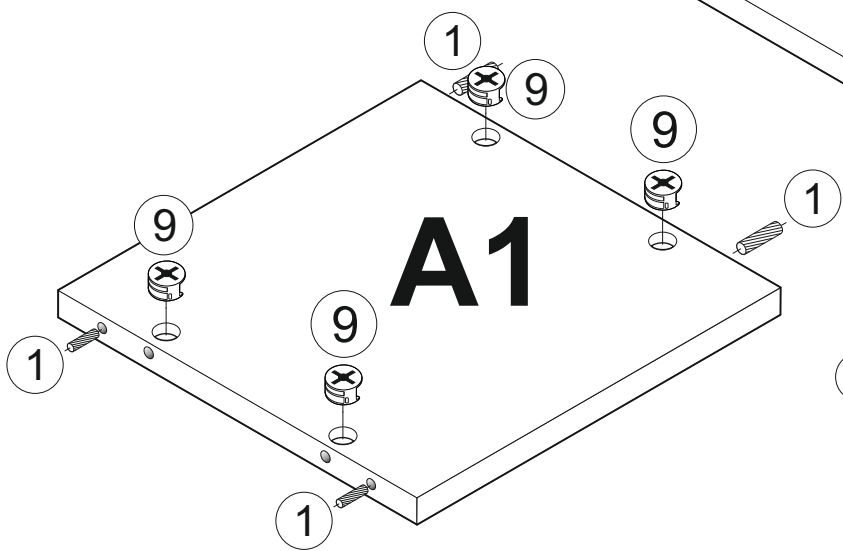
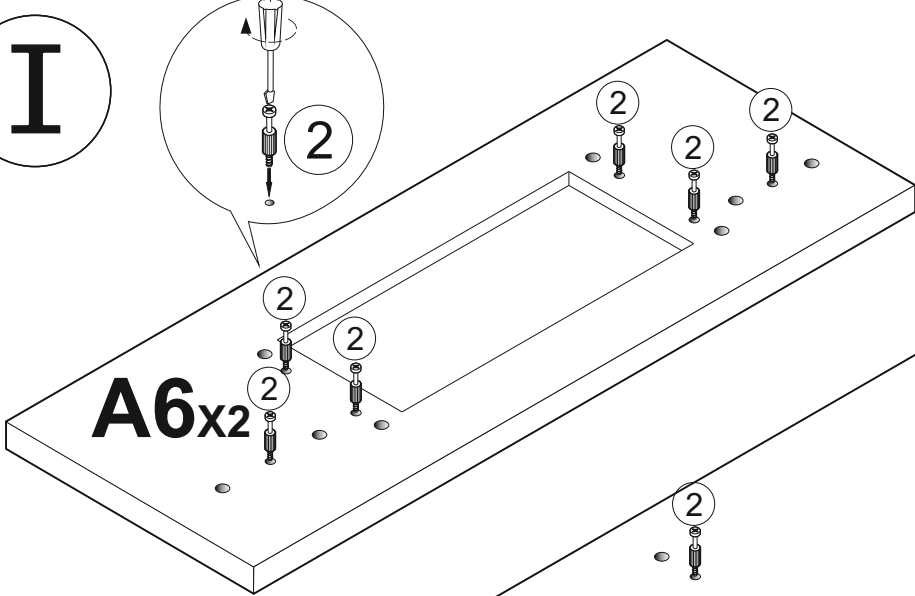

II

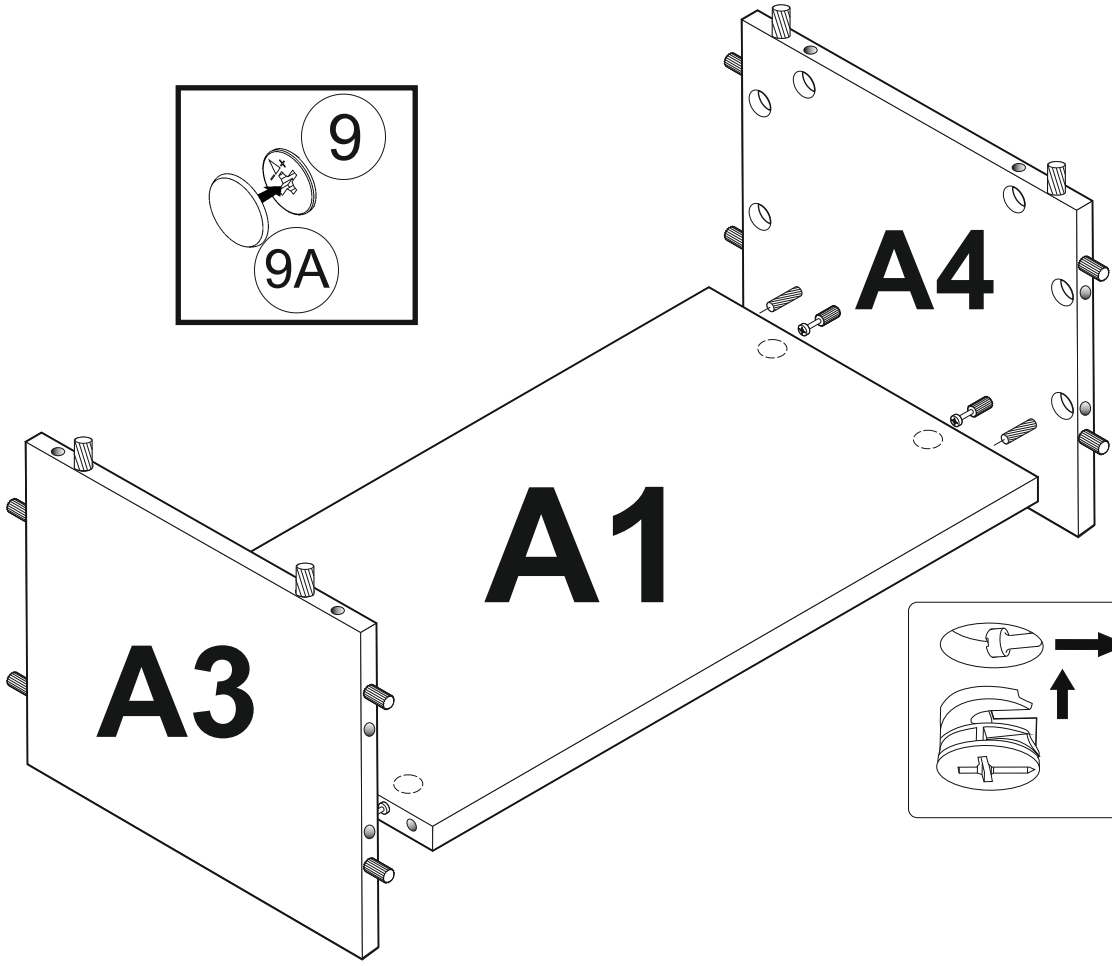

III

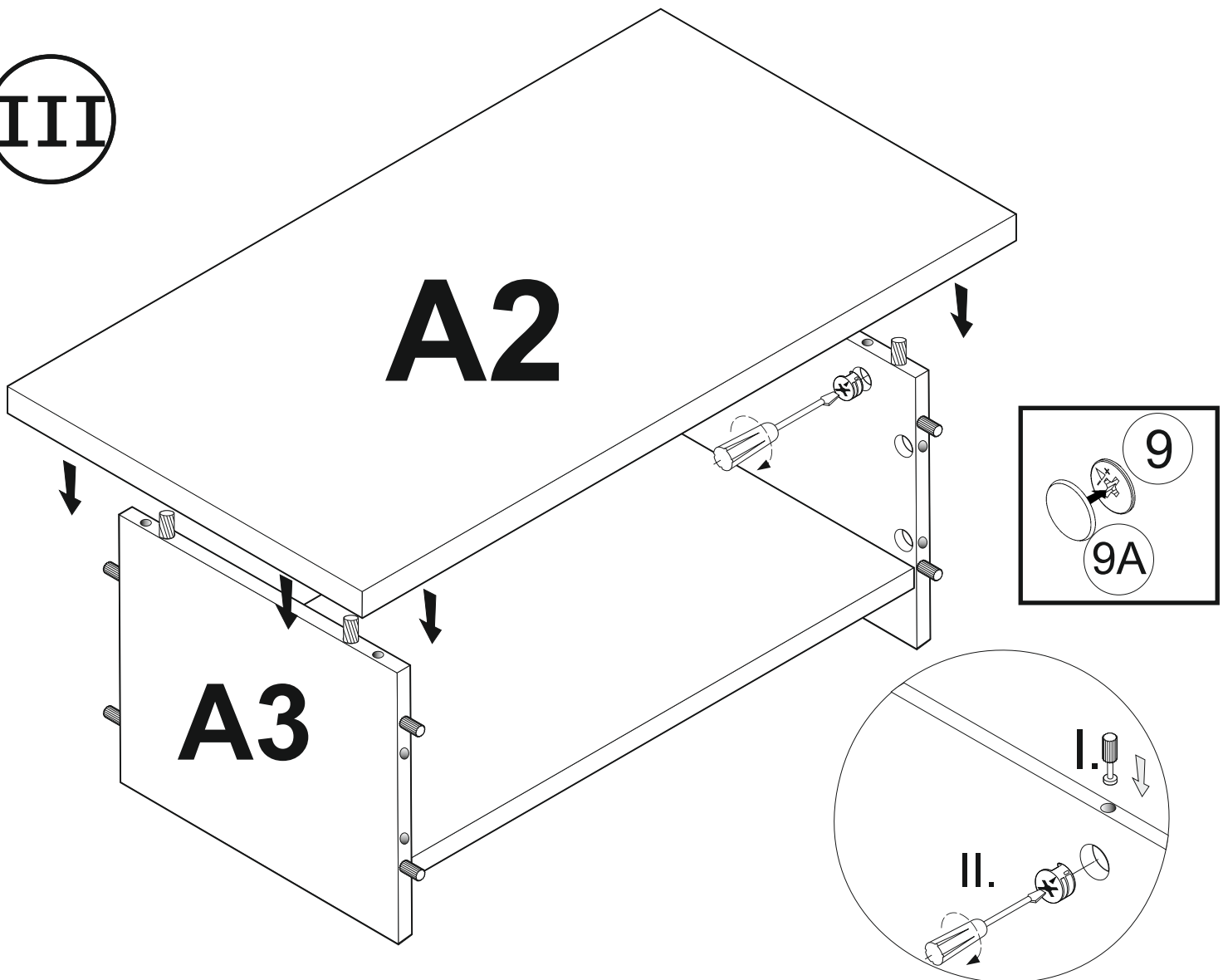

IV

