

HAVANA CONCRETE 90-80

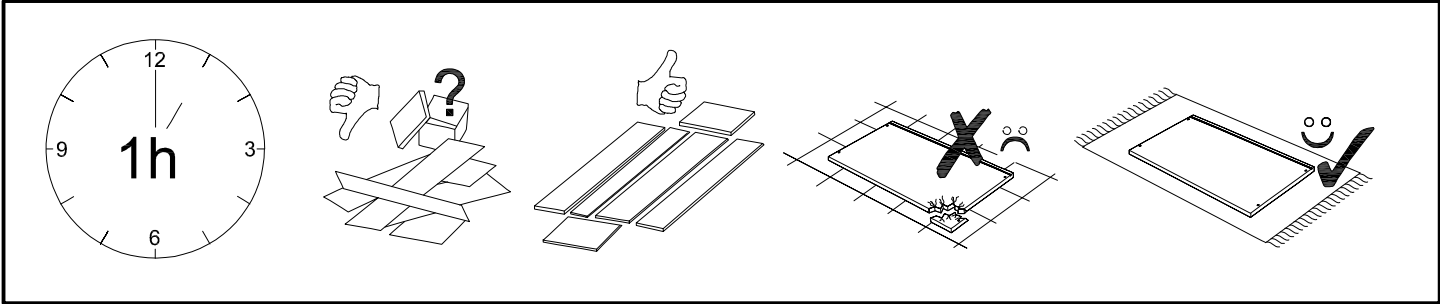

#	S	B	S	Q
1	470	805	22	1

