

# INSTRUKCJA MONTAŻU

FITTING-UP INSTRUCTION / AUFBAUANLEITUNG

MONTÁŽNÍ NÁVOD / MONTÁŽNY NÁVOD

Producent:  
**Restol sp. z o.o.**  
36-055 BRATKOWICE  
www.restol.com.pl

# Theo THK-2

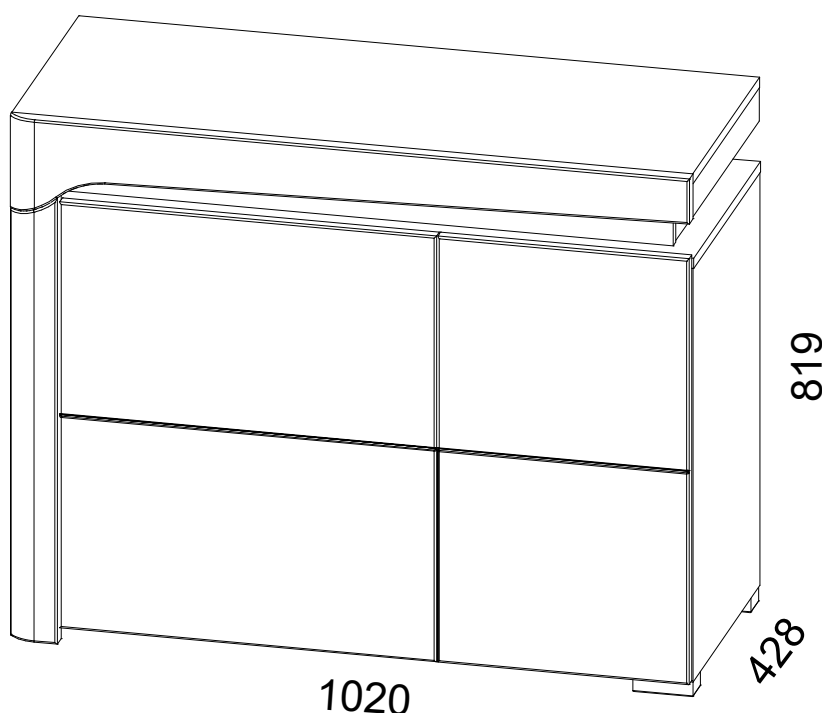

1020 x 819 x 428 /mm/

### **POKYN pro ošetřování nábytku!**

Díly čistit vlhkým hadříkem nebo papírovou utěrkou.

Nepoužívat chemické čisticí prostředky.

### **POKYNY k údržbě nábytku.**

Prvky nábytku čistit vlhkou handričkou alebo papírovou utěrkou.

Nepoužívat chemické čistiace prostriedky.

### **WSKAZÓWKA na temat pielęgnacji mebla.**

Czyścić elementy wilgotną szmatką lub papierowym ręcznikiem.

Nie używać chemicznych środków czyszczących.

### **DIRECTION for the furniture cleaning.**

Clean elements with the moist wiper or soft paper towel. Do not use any detergents.

### **Pflegehinweis.**

Nur mit feuchtem Lappen, bzw. Papiertuch Ihre Möbel reinigen. Keine chemischen Waschmittel einsetzen.

INSTRUKCJA MONTAŻU  
FITTING-UP INSTRUCTION / AUFBAUANLEITUNG  
MONTÁŽNÍ NÁVOD / MONTÁŽNY NÁVOD

# Theo THK-2

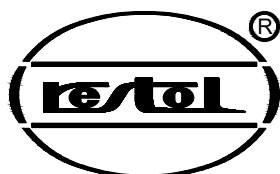

Do montażu potrzebne są:

You need for fitting-up:

Zur Montage werden Sie brauchen:

K montáži jsou potřebné:

Na montáž potrebujete:

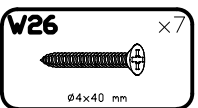
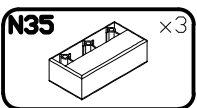
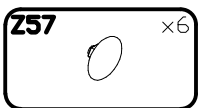
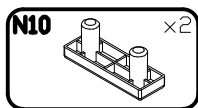
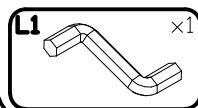
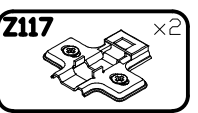
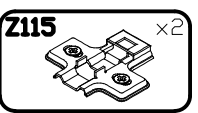
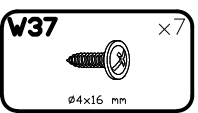
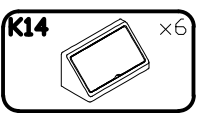
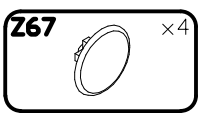
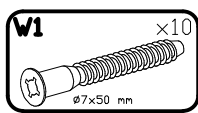
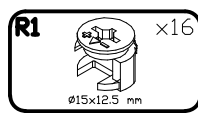
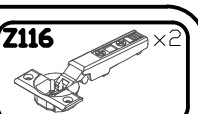
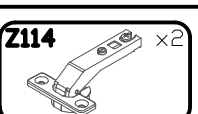
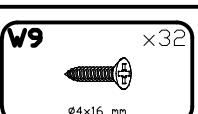
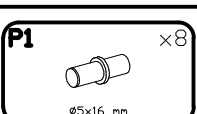
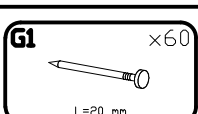
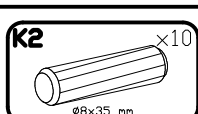
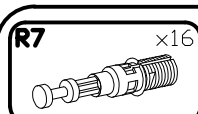
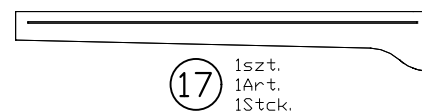
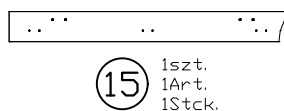
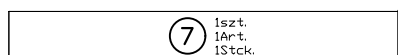
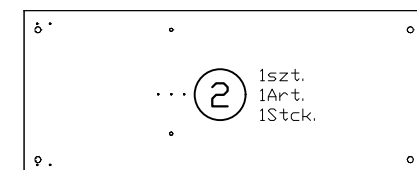
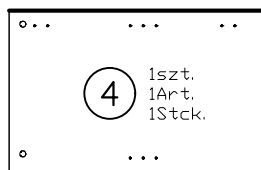
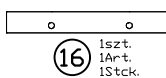
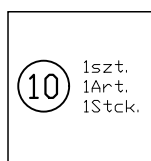
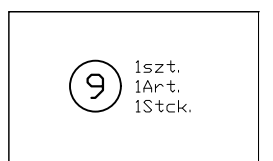
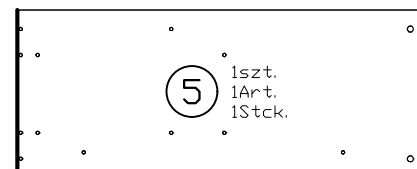
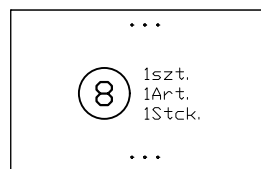
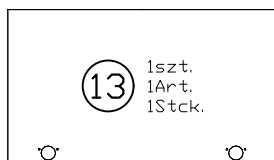
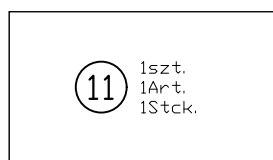
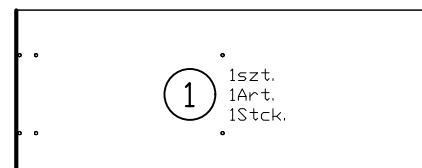
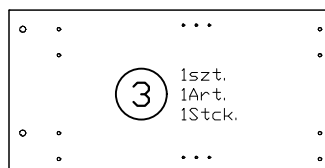
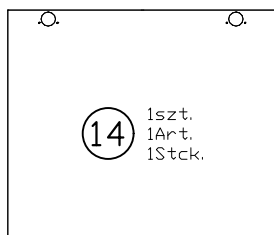
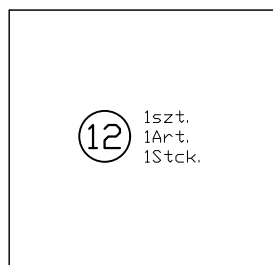
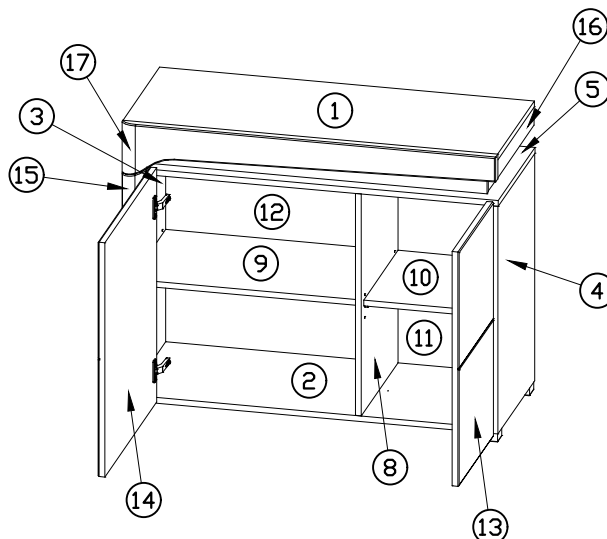
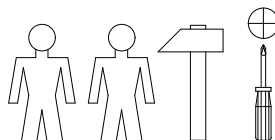

PODCZAS MONTAŻU POSTĘPOWAĆ ZGODNIE Z INSTRUKCJĄ  
 WHILE ASSEMBLING FOLLOW THE INSTRUCTION / MONTAGE LAUT DER AUFBAUANLEITUNG DURCHFÜHREN  
 PŘI MONTÁŽI POSTUPOVAT PODLE NÁVODU / PRI MONTÁŽI POSTUPOJTE PODĽA NÁVODU

# 1<sup>THco</sup> THK-2

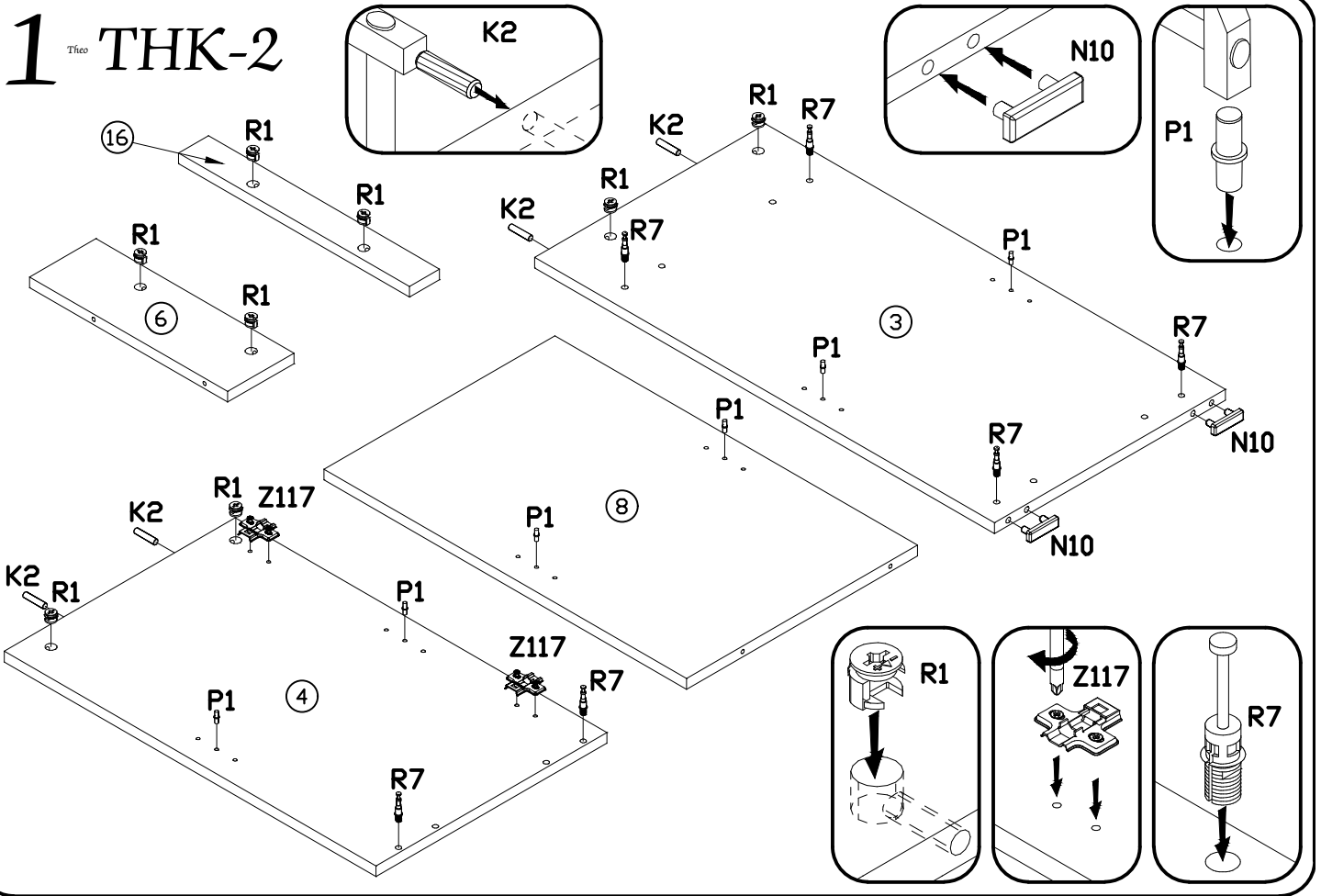

# 2<sup>THco</sup> THK-2

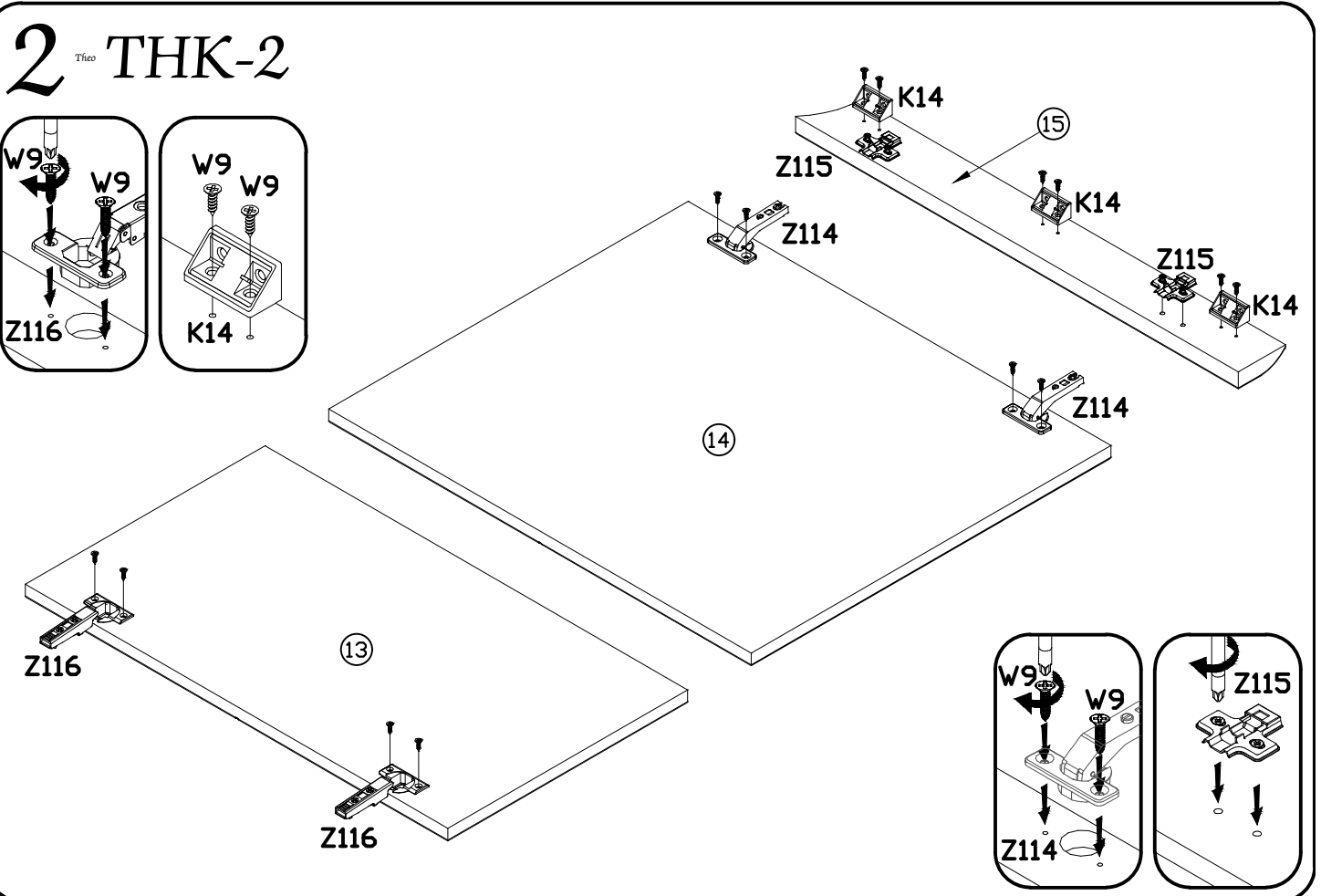

PODCZAS MONTAŻU POSTĘPOWAĆ ZGODNIE Z INSTRUKCJĄ  
WHILE ASSEMBLING FOLLOW THE INSTRUCTION / MONTAGE LAUT DER AUFBAUANLEITUNG DURCHFÜHREN  
PŘI MONTÁŽI POSTUPOVAT PODLE NÁVODU / PRI MONTÁŽI POSTUPOJTE PODĽA NÁVODU

### 3 THK-2

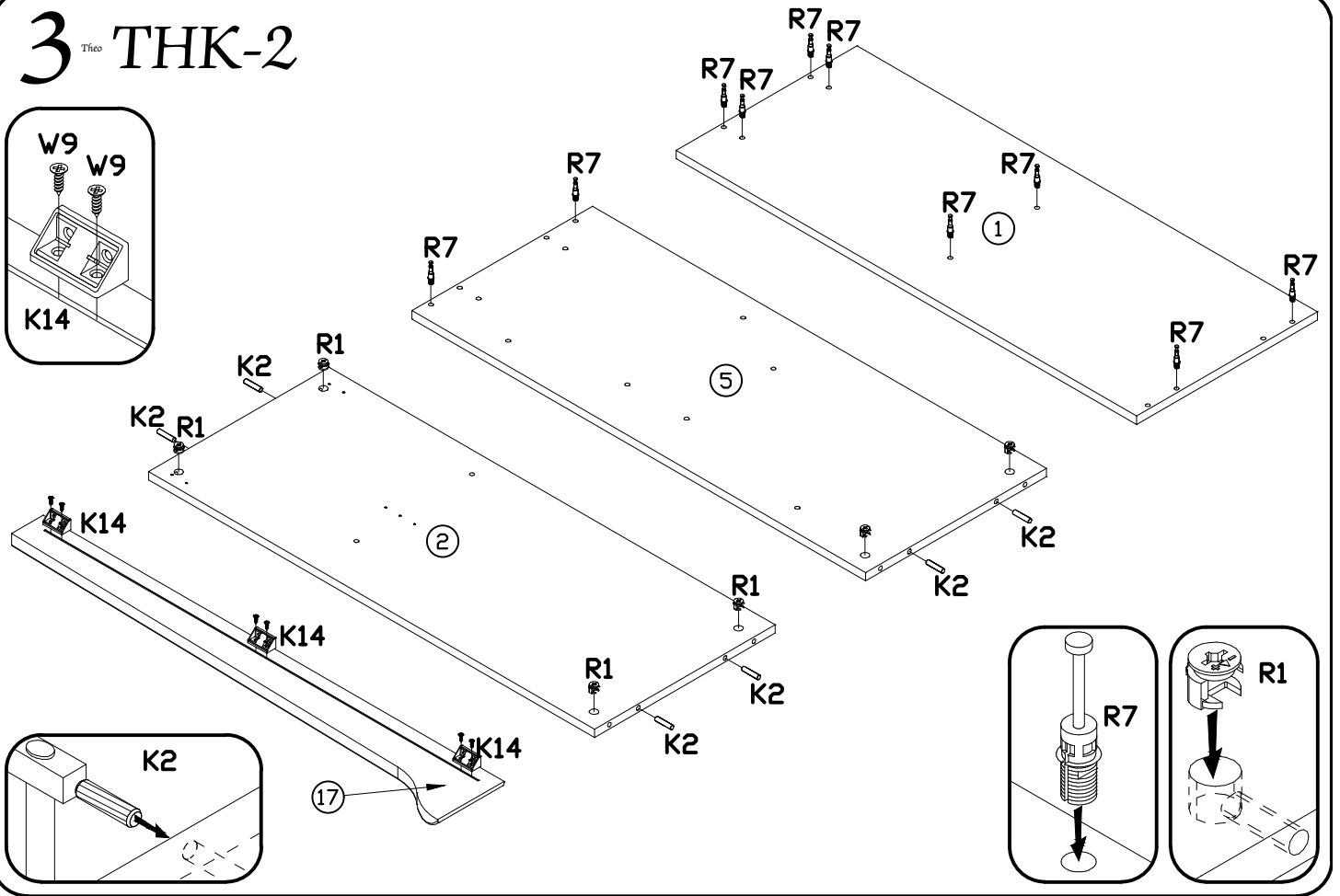

### 4 THK-2

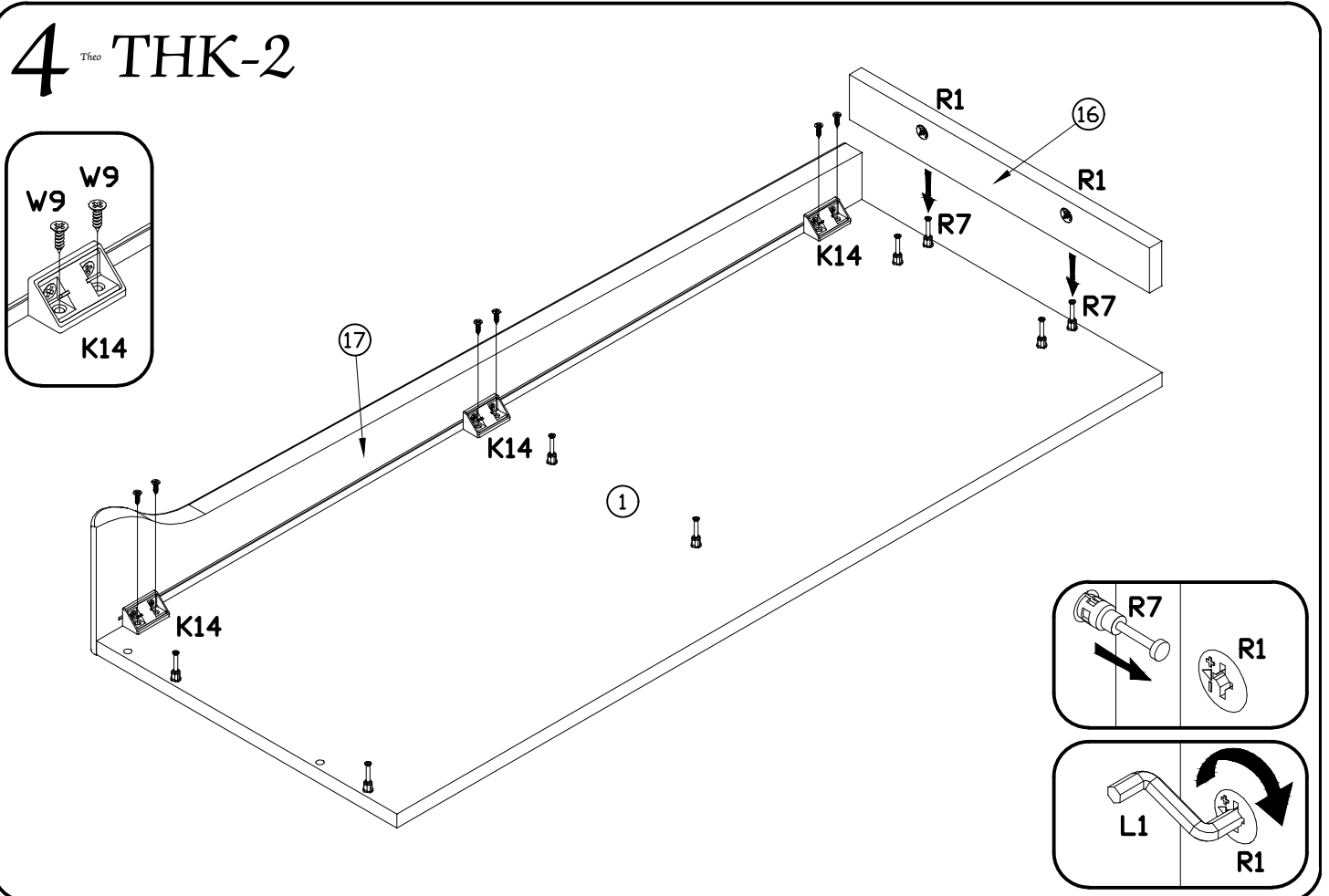

PODCZAS MONTAŻU POSTĘPOWAĆ ZGODNIE Z INSTRUKCJĄ  
 WHILE ASSEMBLING FOLLOW THE INSTRUCTION / MONTAGE LAUT DER AUFBAUANLEITUNG DURCHFÜHREN  
 PŘI MONTÁŽI POSTUPOVAT PODLE NÁVODU / PRI MONTÁŽI POSTUPOJTE PODĽA NÁVODU

# 5<sup>THCO</sup> THK-2 - Opcja NEO-8

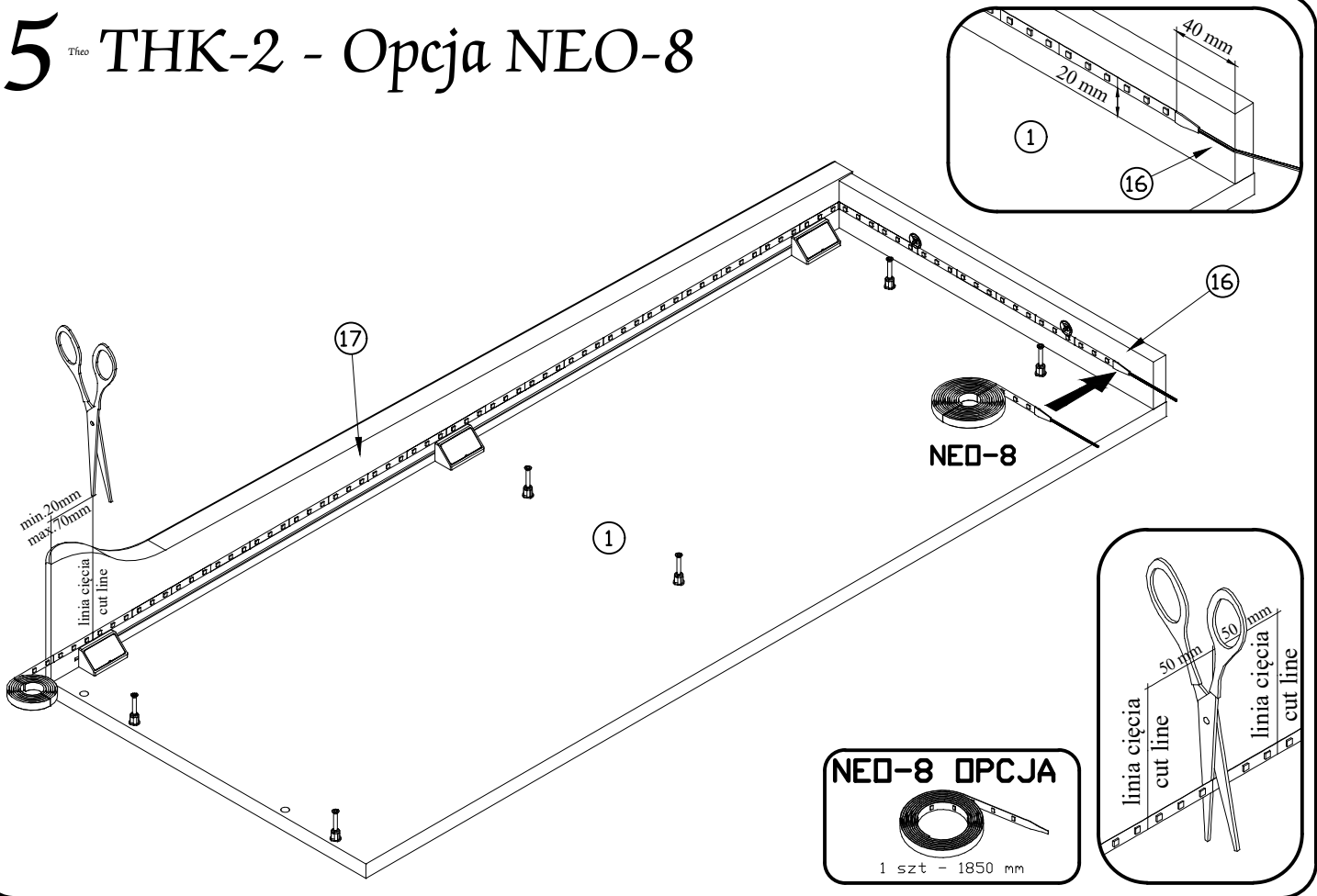

# 6<sup>THCO</sup> THK-2

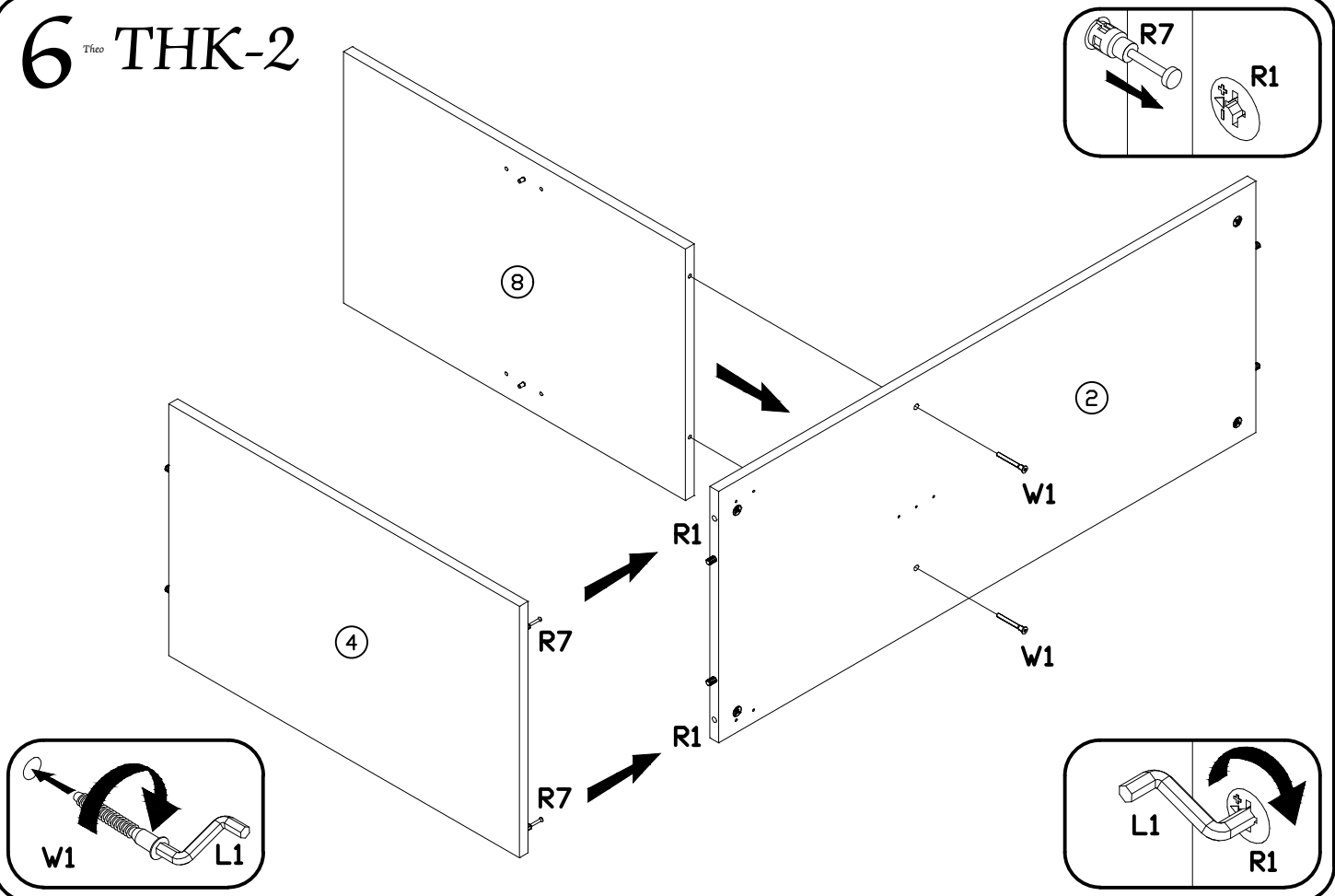

PODCZAS MONTAŻU POSTĘPOWAĆ ZGODNIE Z INSTRUKCJĄ  
WHILE ASSEMBLING FOLLOW THE INSTRUCTION / MONTAGE LAUT DER AUFBAUANLEITUNG DURCHFÜHREN  
PŘI MONTÁŽI POSTUPOVAT PODLE NÁVODU / PRI MONTÁŽI POSTUPOJTE PODĽA NÁVODU

# 7<sup>TH</sup> THK-2

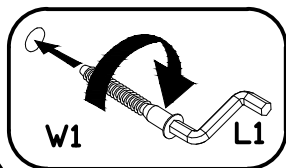
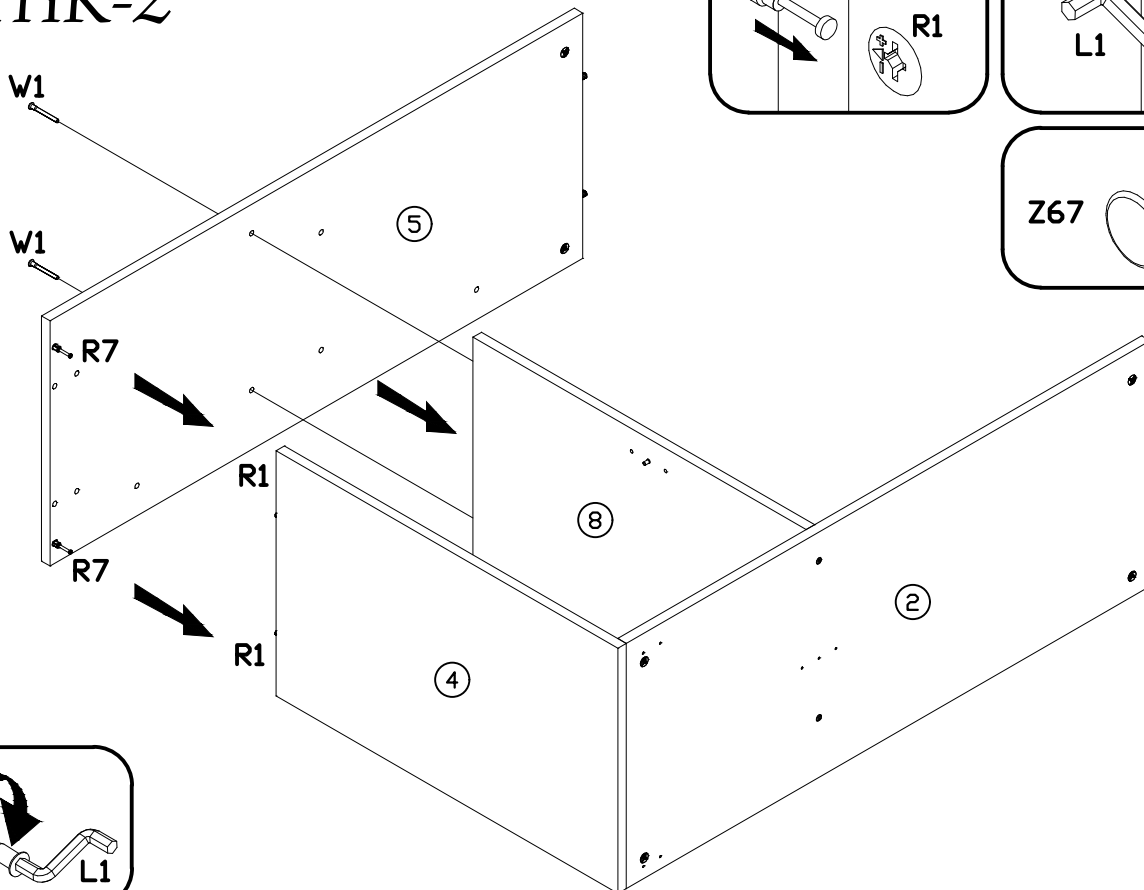

# 8<sup>TH</sup> THK-2

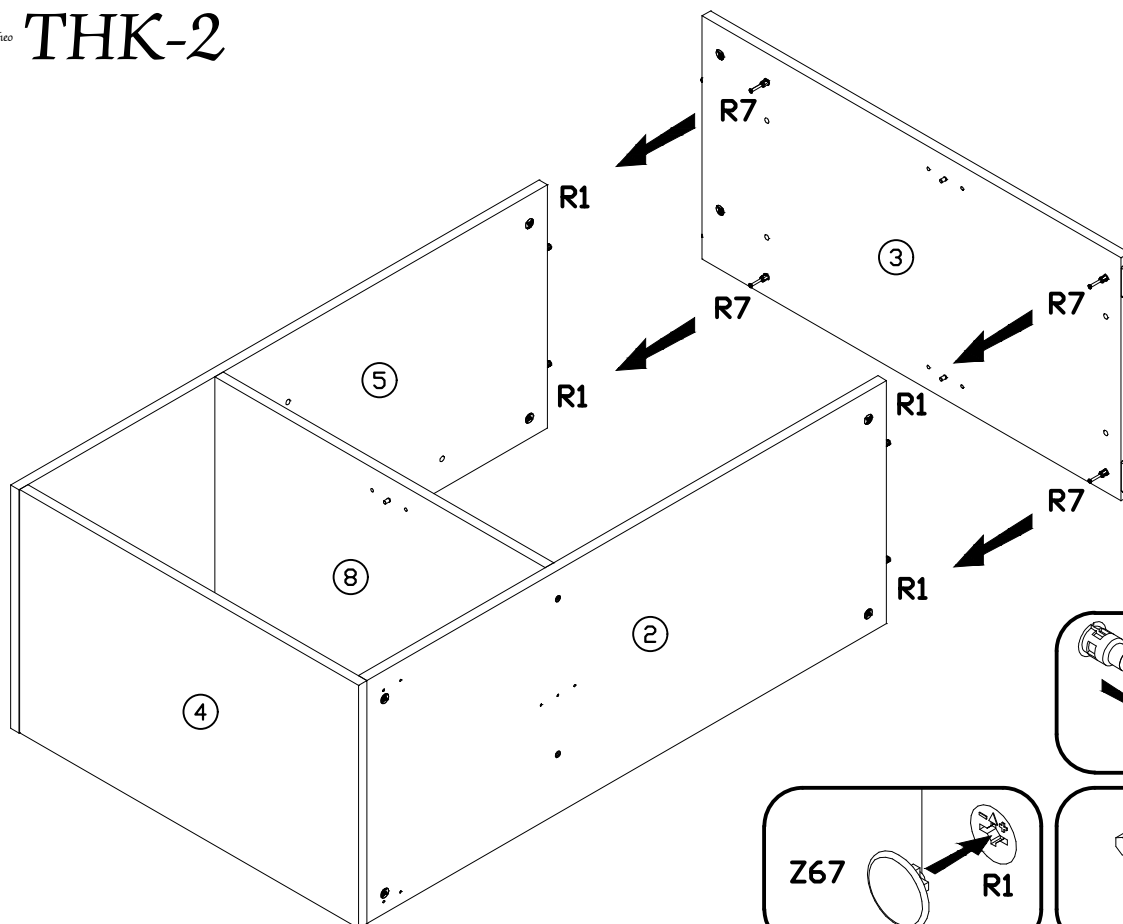

PODCZAS MONTAŻU POSTĘPOWAĆ ZGODNIE Z INSTRUKCJĄ  
 WHILE ASSEMBLING FOLLOW THE INSTRUCTION / MONTAGE LAUT DER AUFBAUANLEITUNG DURCHFÜHREN  
 PŘI MONTÁŽI POSTUPOVAT PODLE NÁVODU / PRI MONTÁŽI POSTUPOJTE PODĽA NÁVODU

# 9<sup>THK-2</sup>

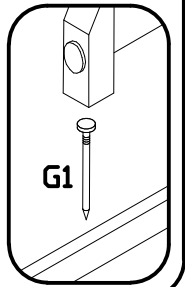
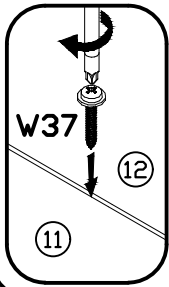
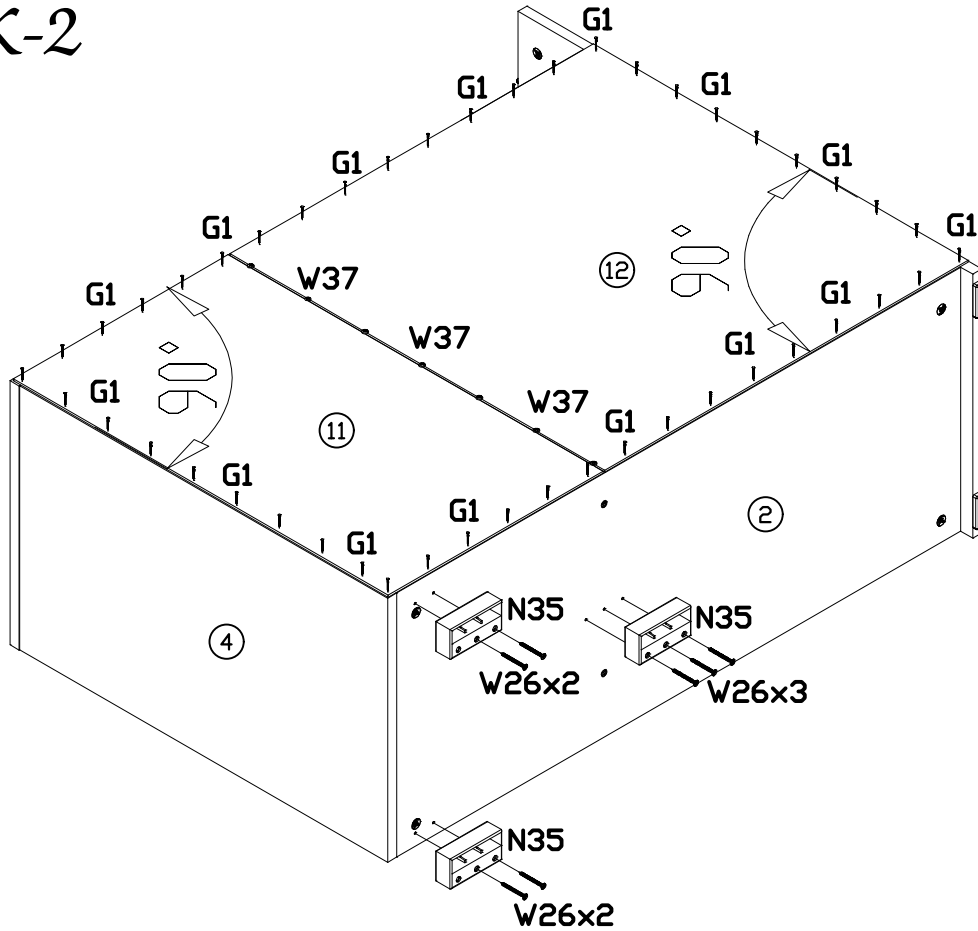

# 10<sup>THK-2</sup>

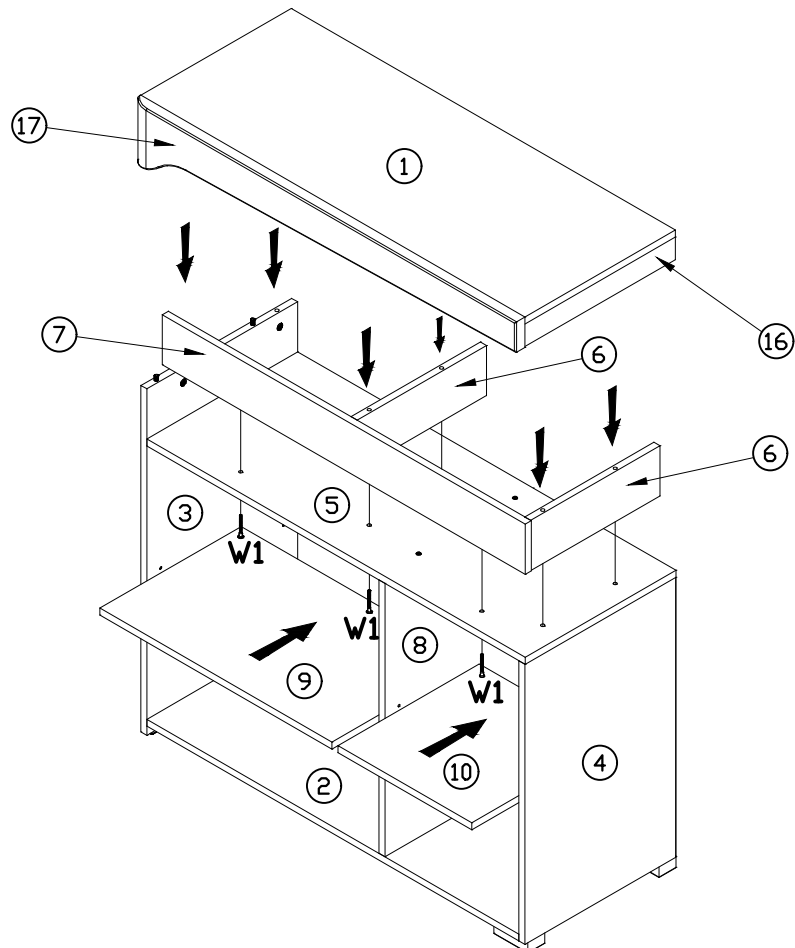
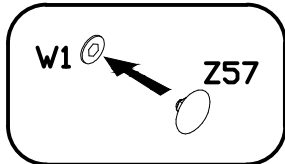
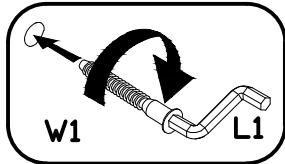
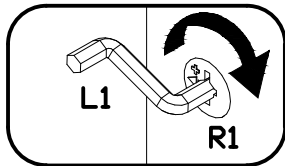
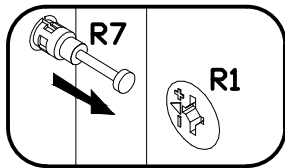

# 11 Tfeco THK-2

