

X

ZŚ2
x 5

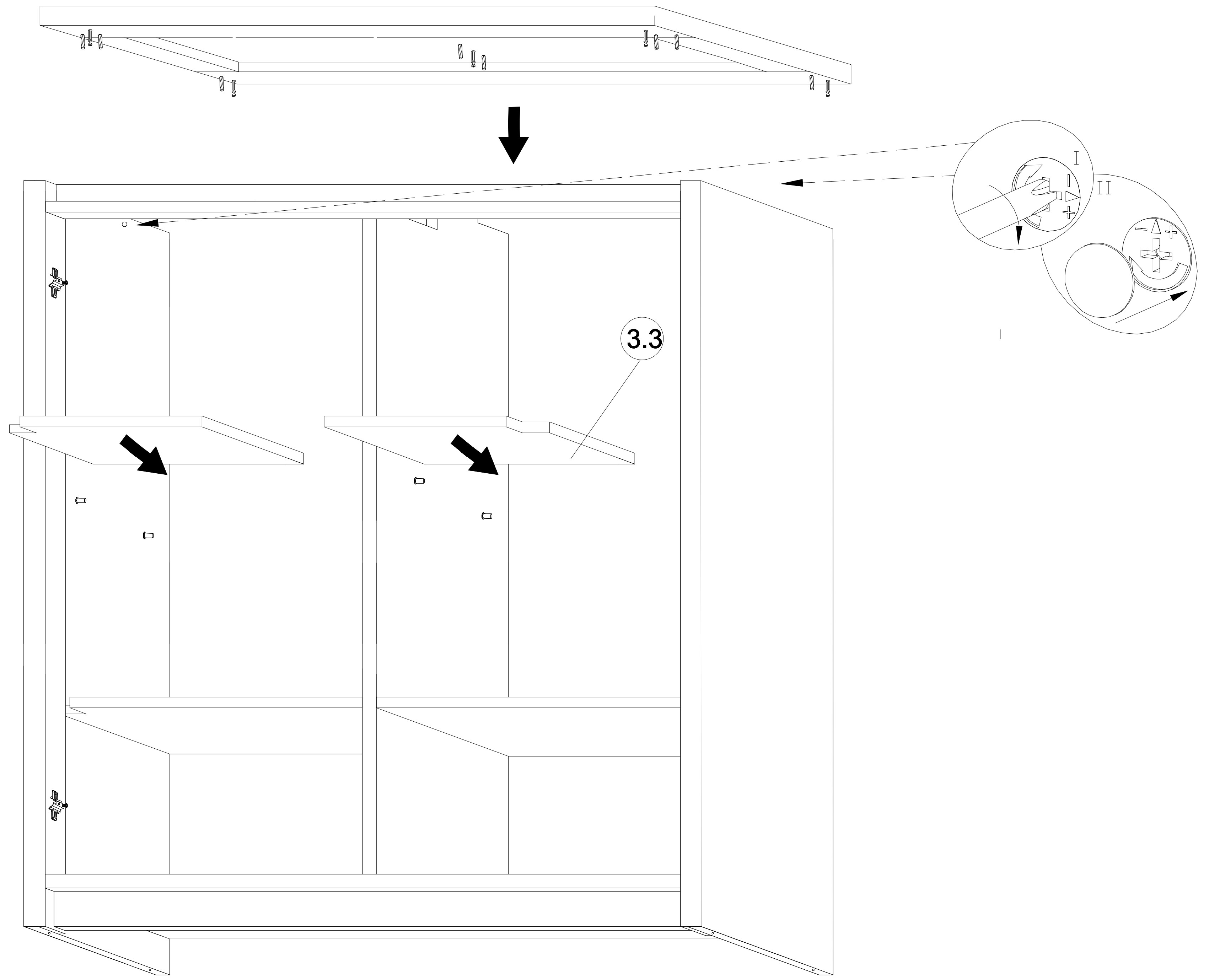

XI

GW
x 40

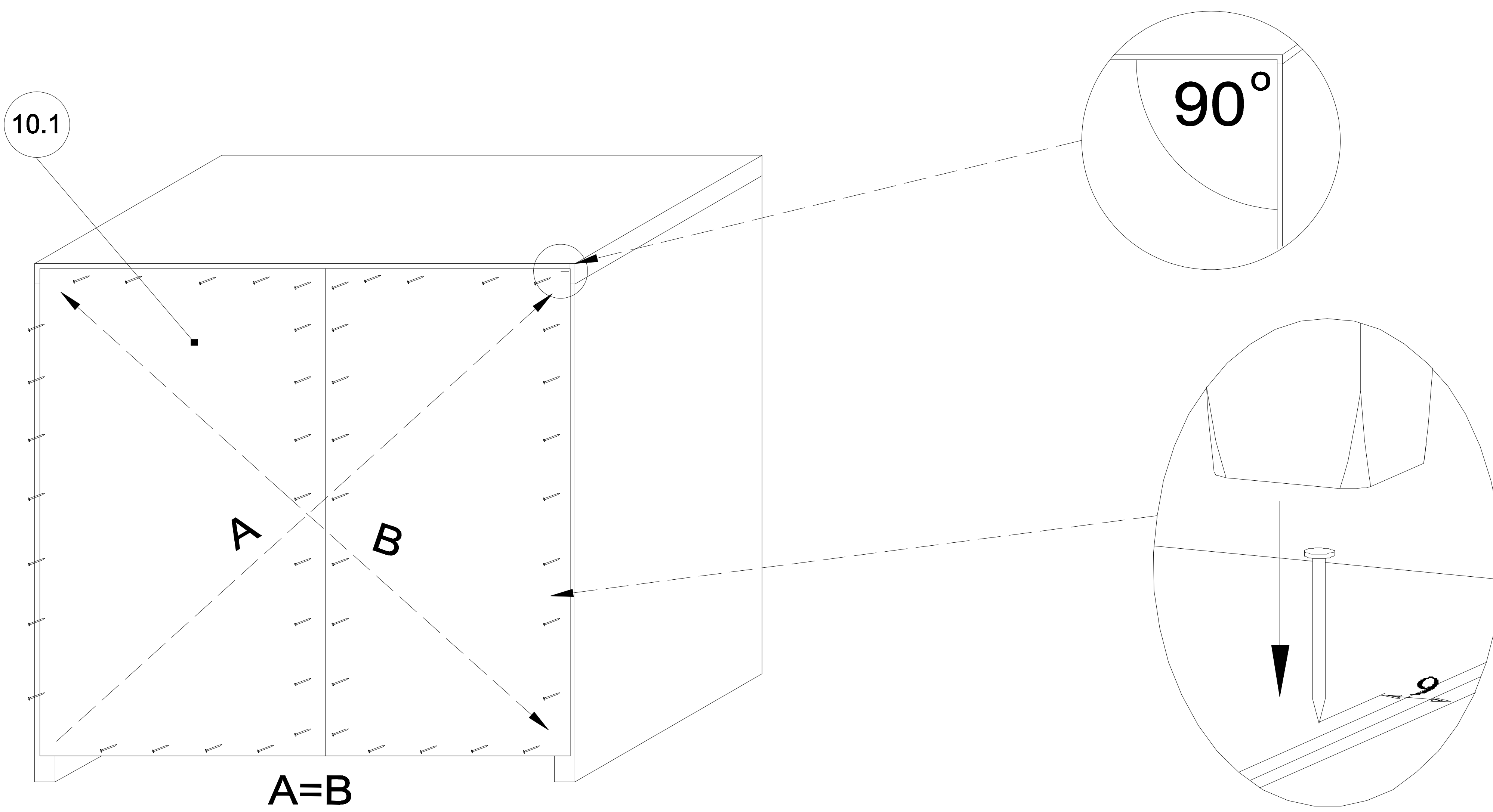

XII

