

L

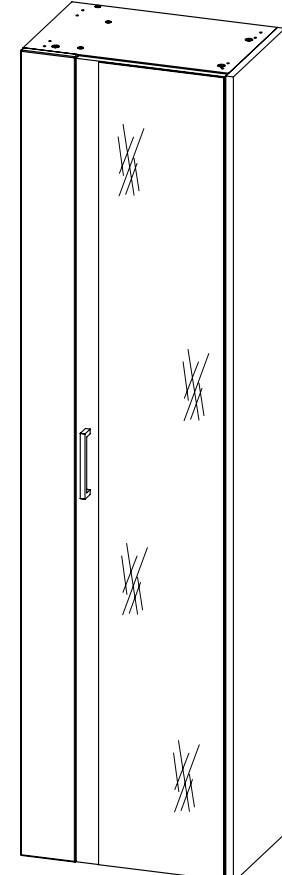

R

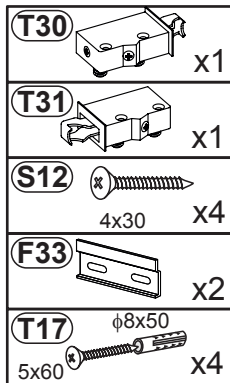
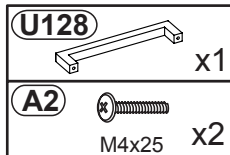
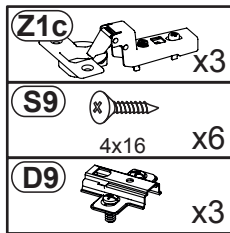
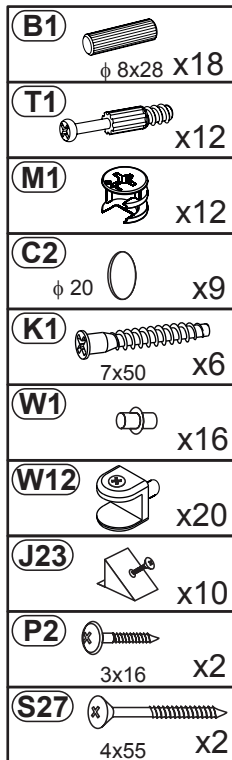

Nr	Ausmaß			St
2	258	98	4	5
3	1700	300	16	1
4	1668	283	16	1
5	1696	314	20	1
6	318	263	16	1
7	318	260	16	4
8	1668	99	16	1
9	434	283	16	1
10	434	283	16	1
11	1700	116	16	1
12	1682	332	2	1

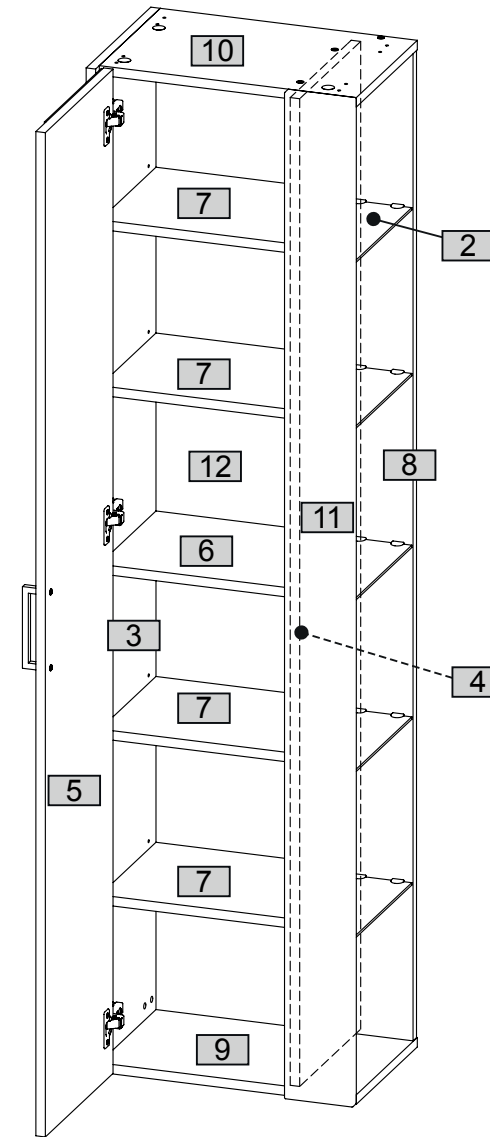

1L

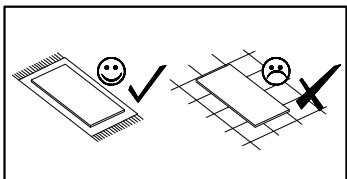
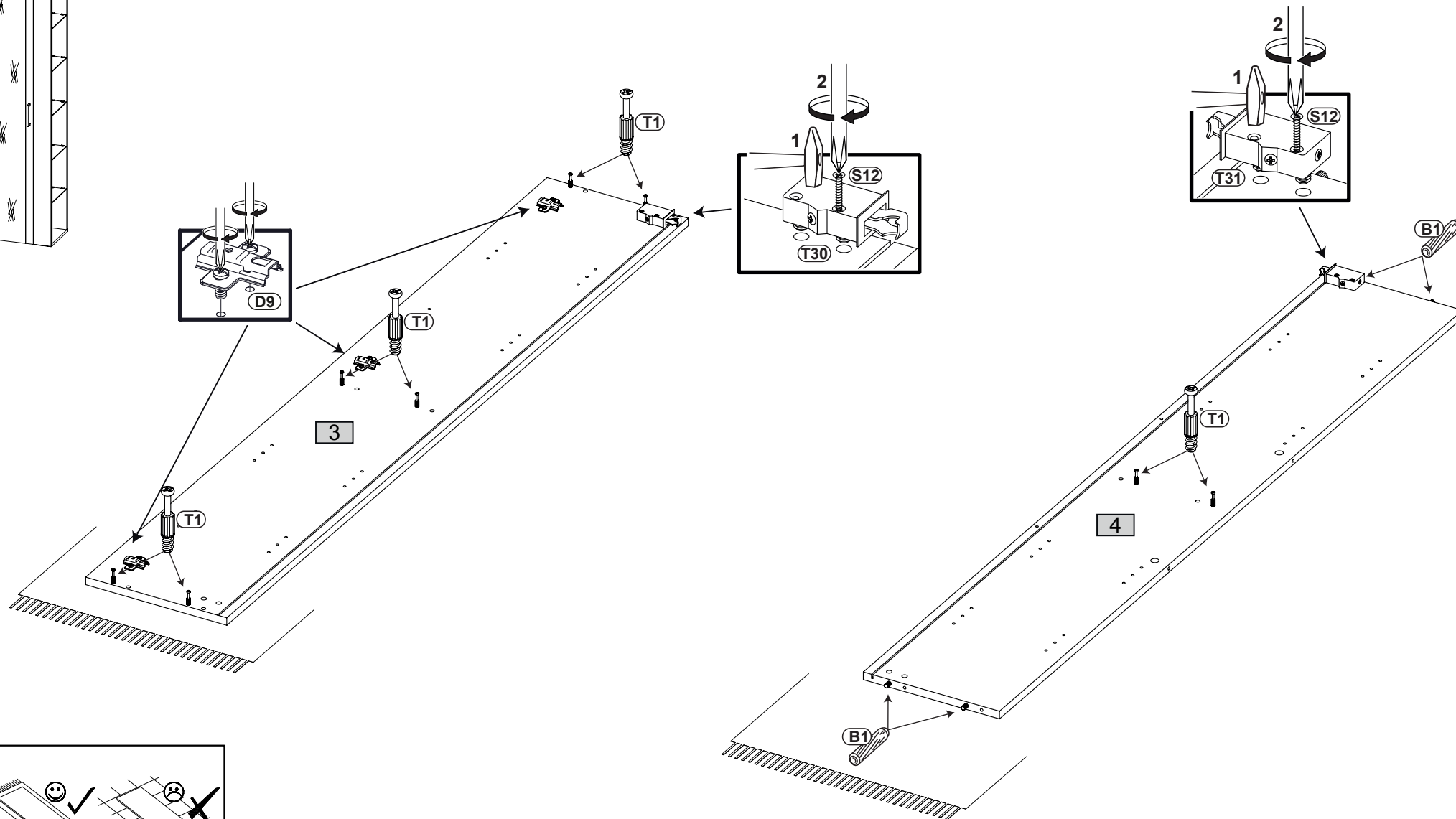
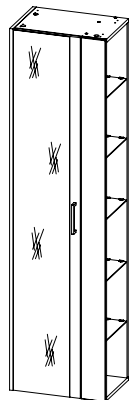
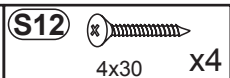
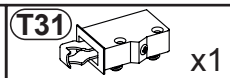
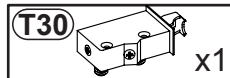
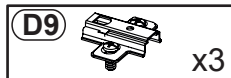
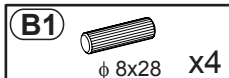
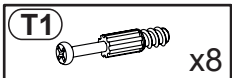

2

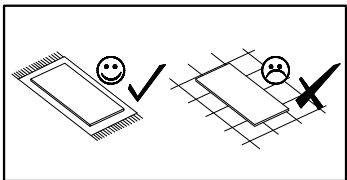
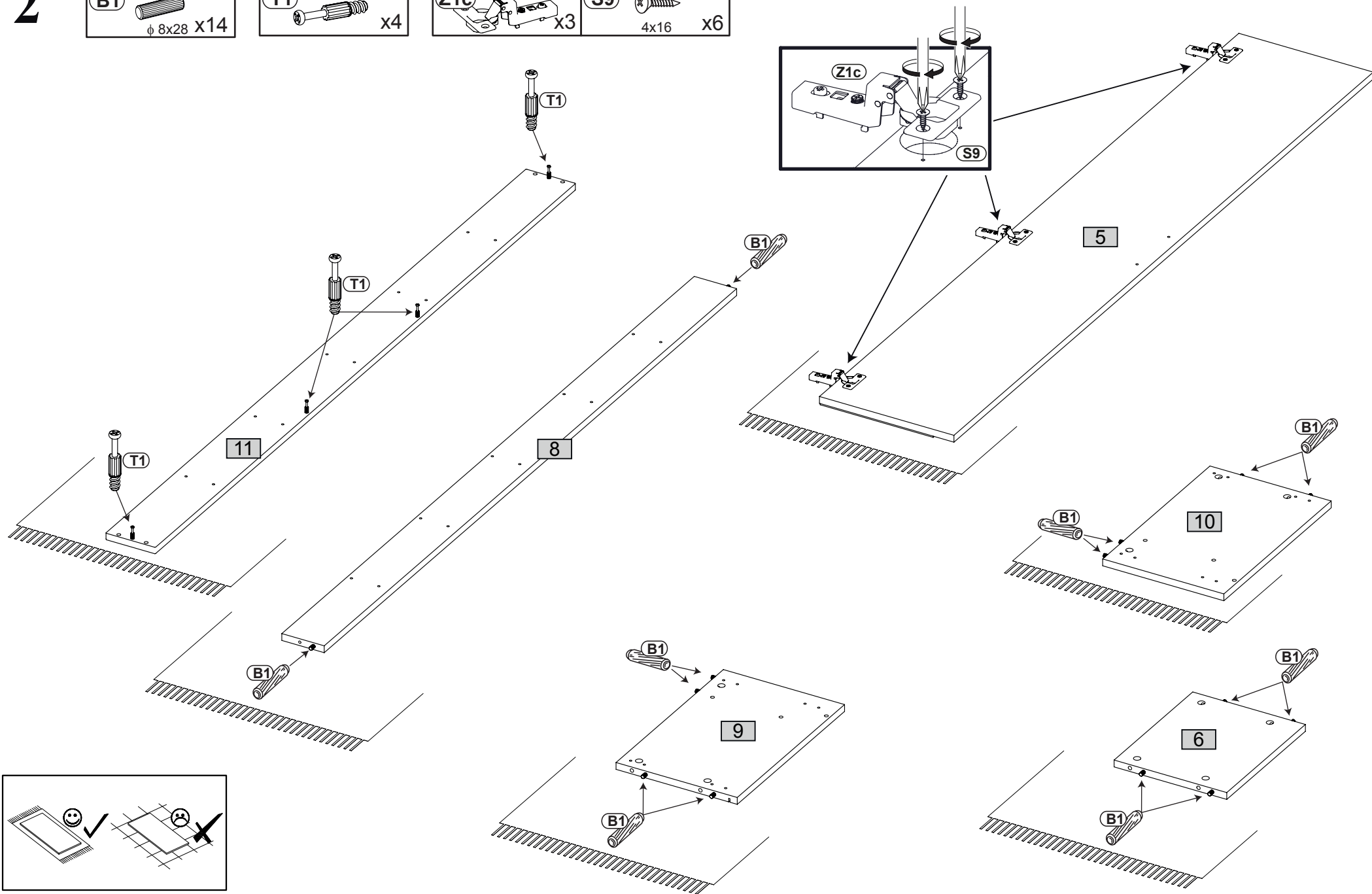
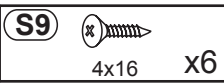
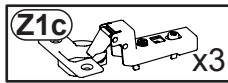
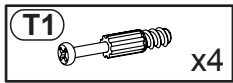
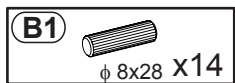

3L

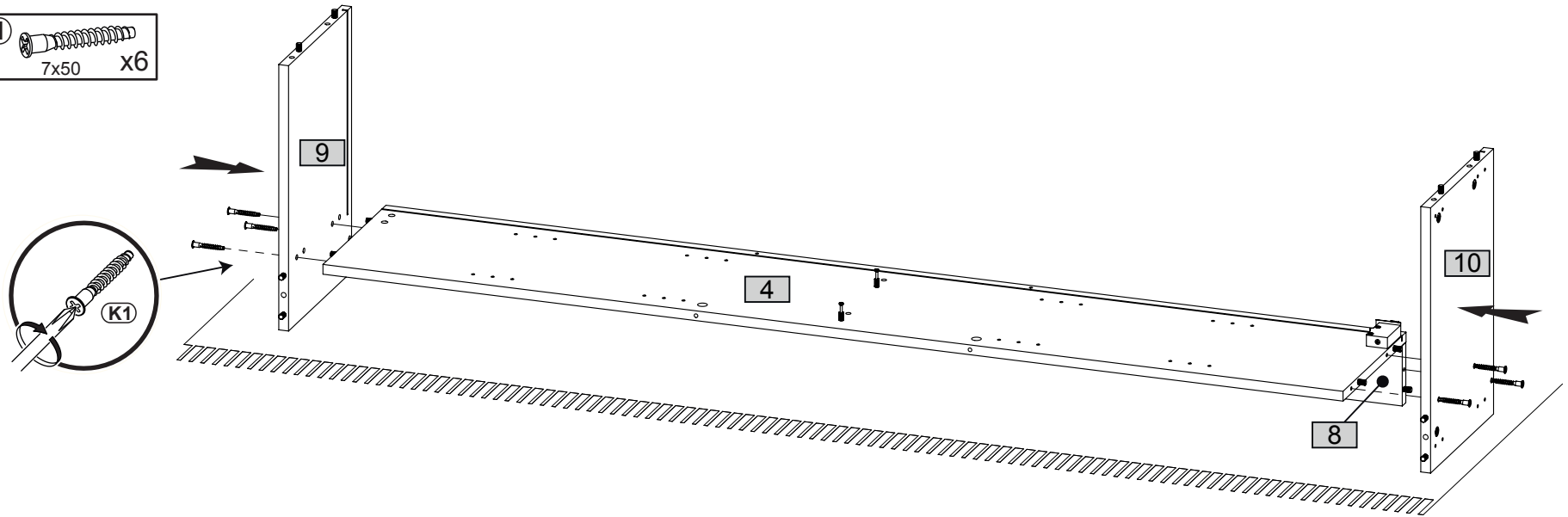
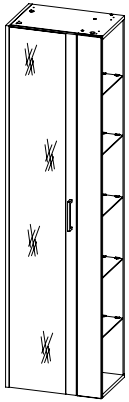
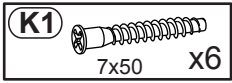

4L

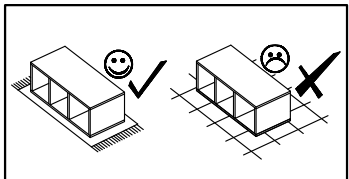
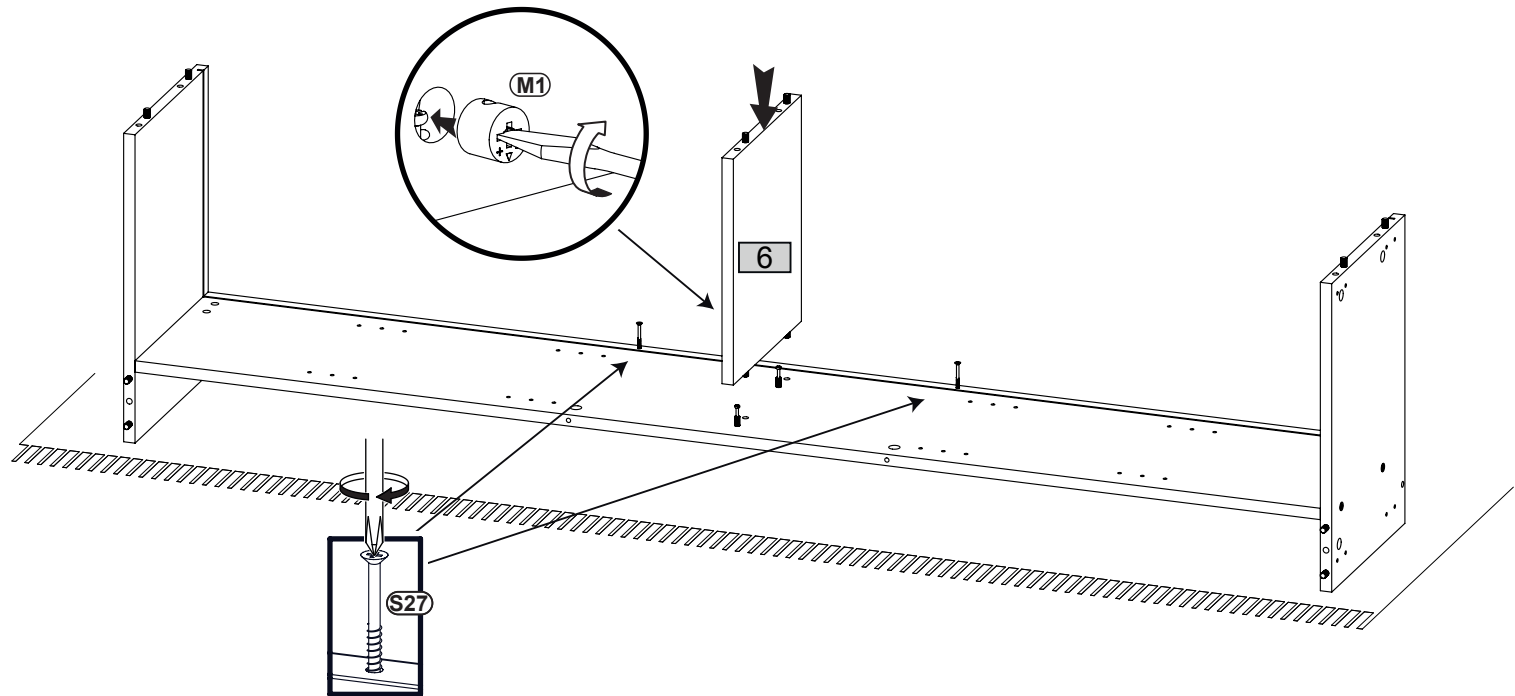
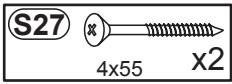

5L



x6

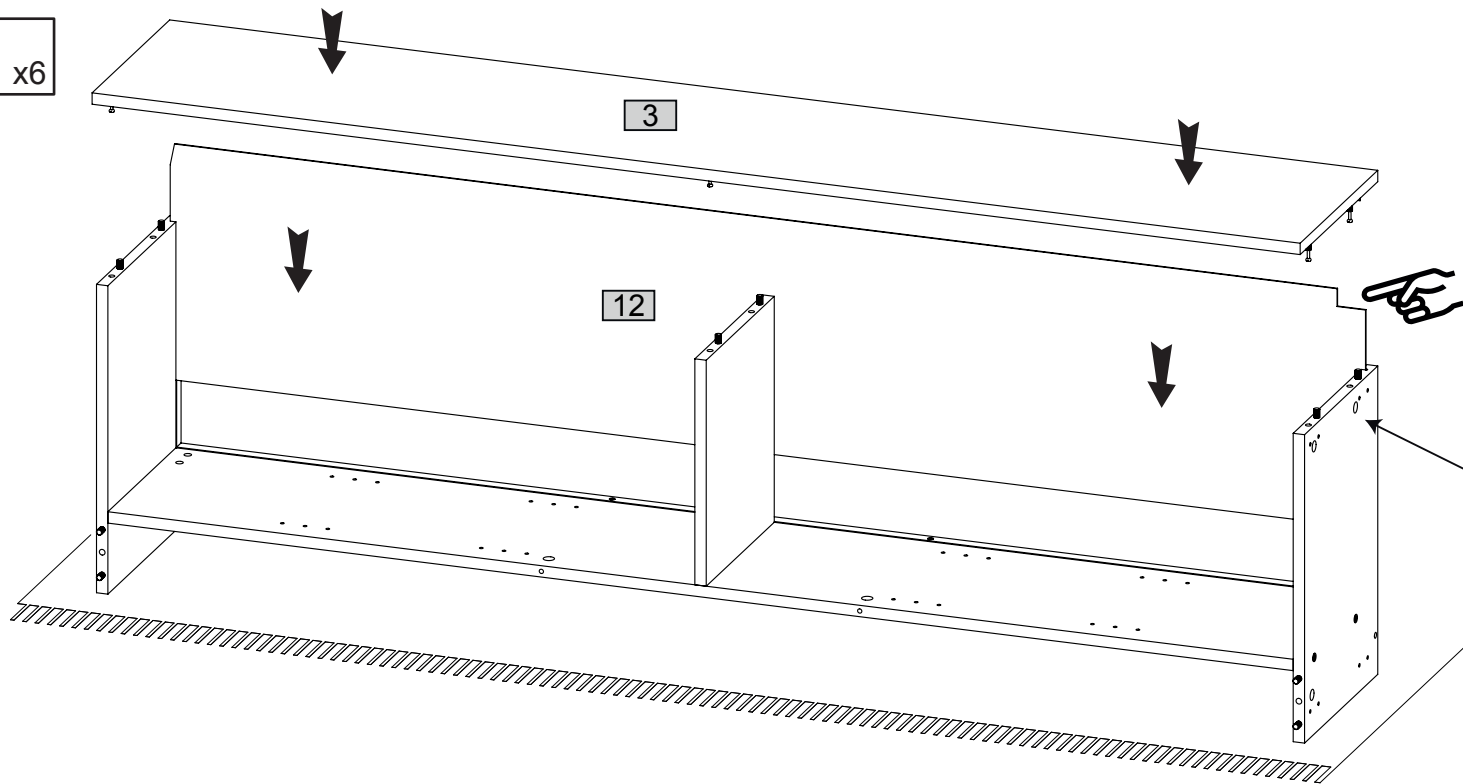

6L



x4

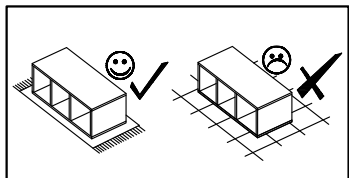
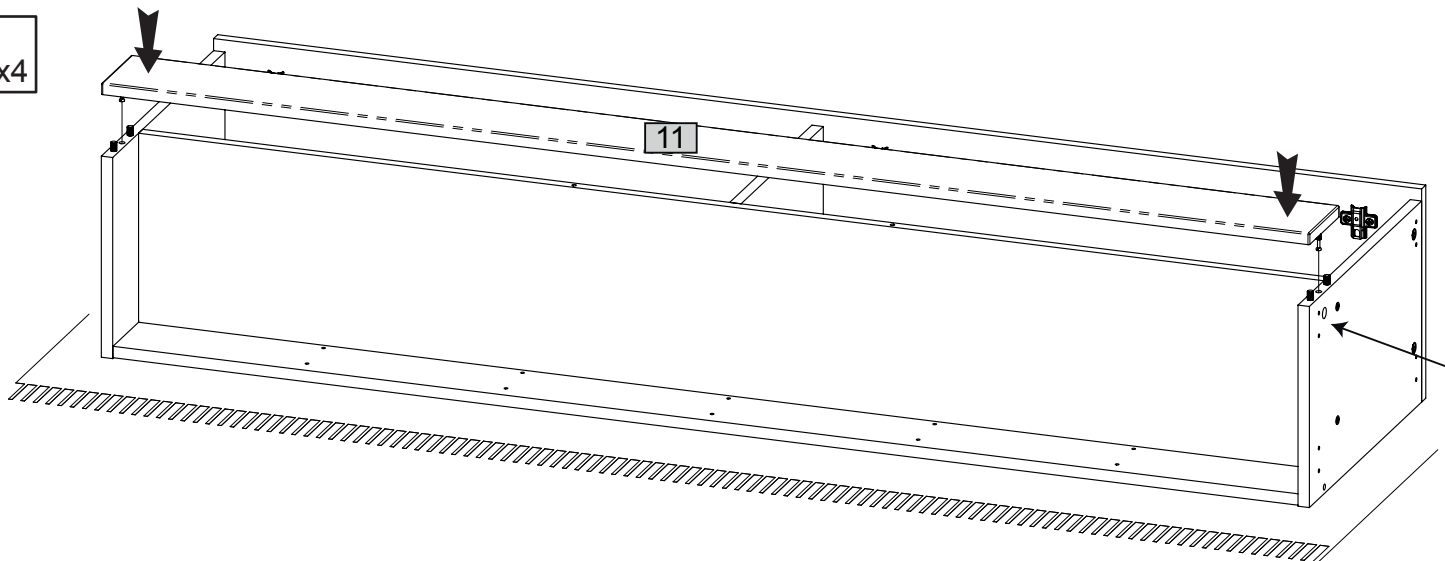

7L

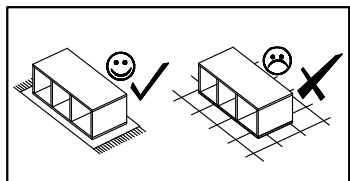
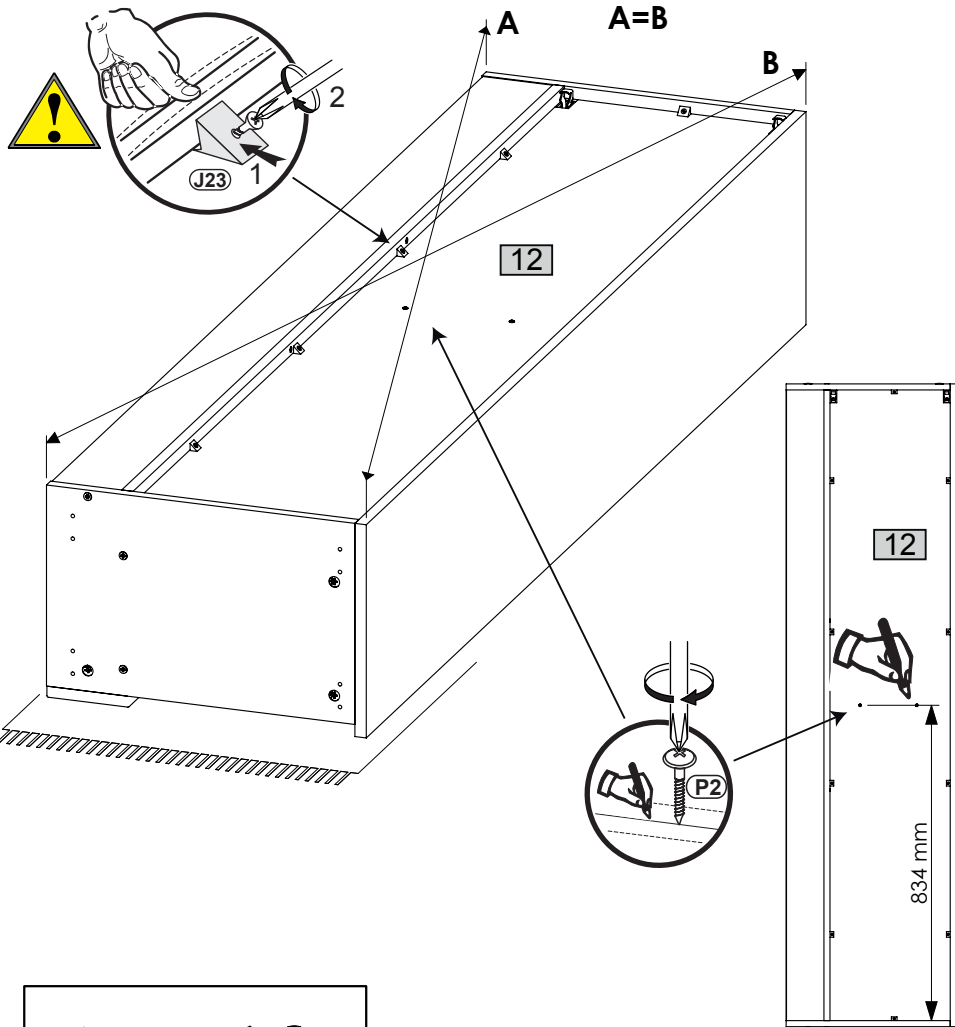
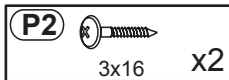
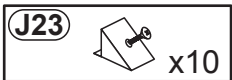

8L

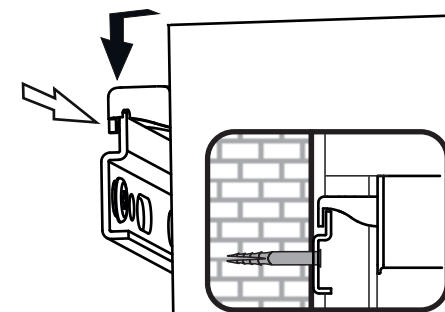
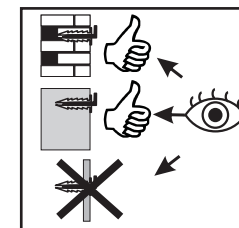
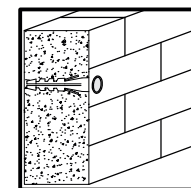
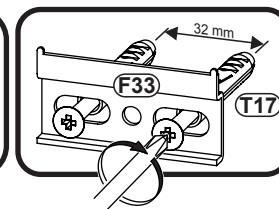
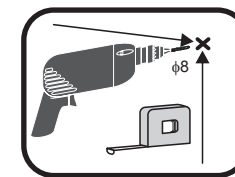
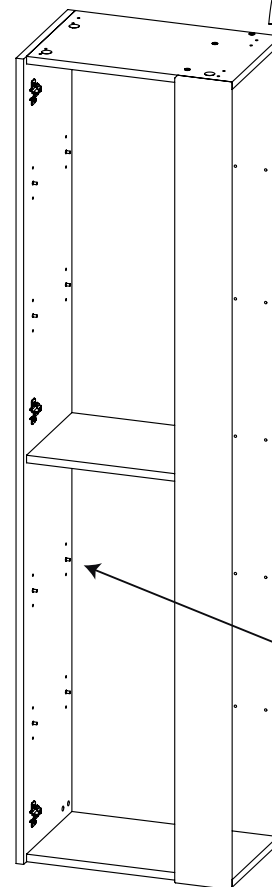
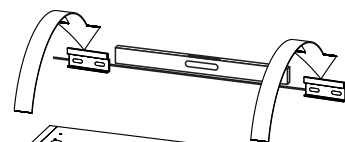
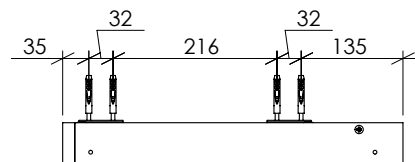
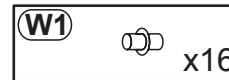
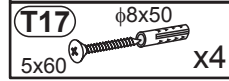
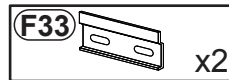

9L

U128



x1

A2



M4x25 x2

C2



φ 20 x9

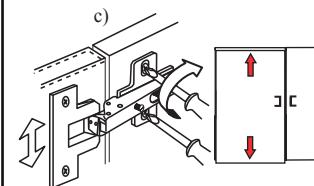
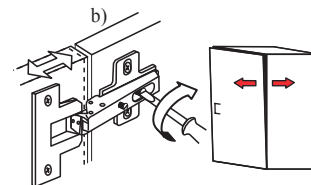
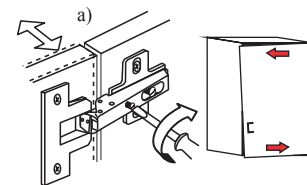
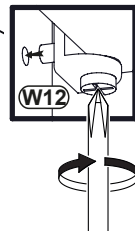
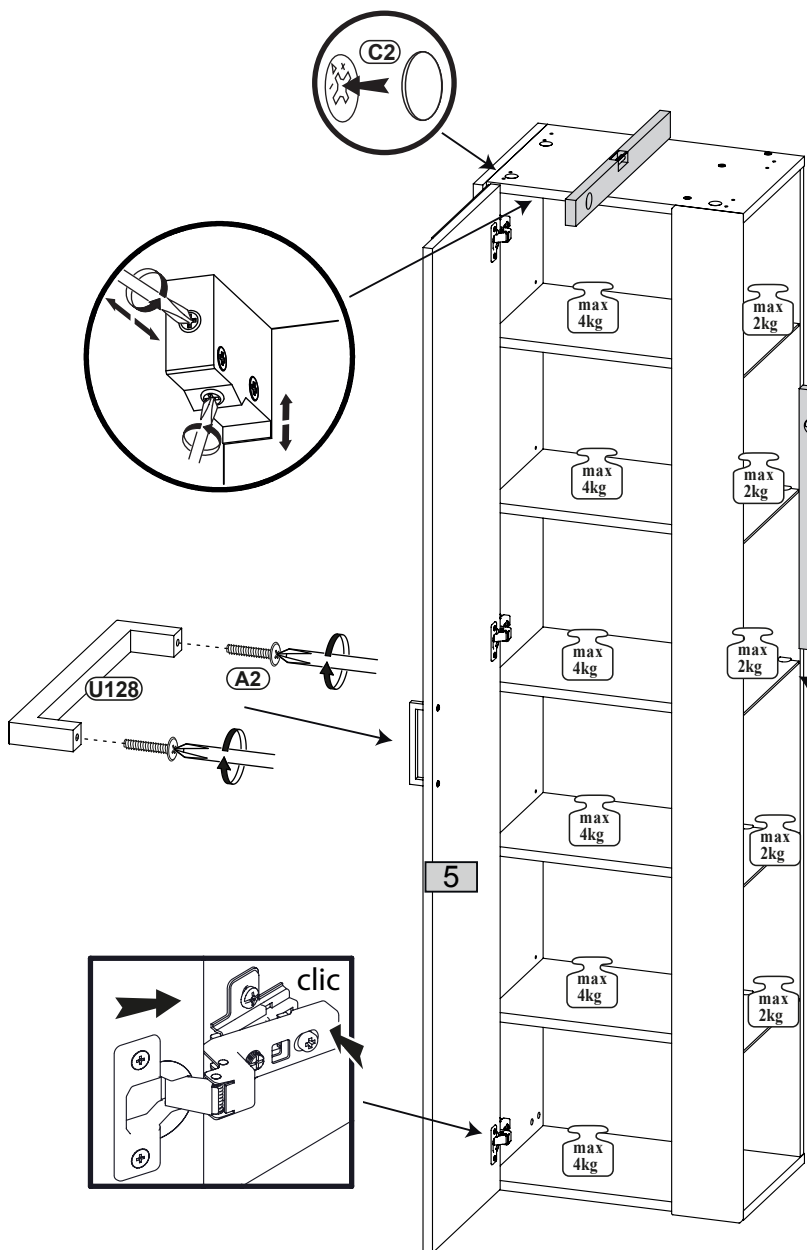

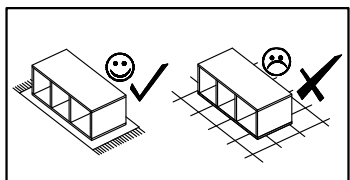
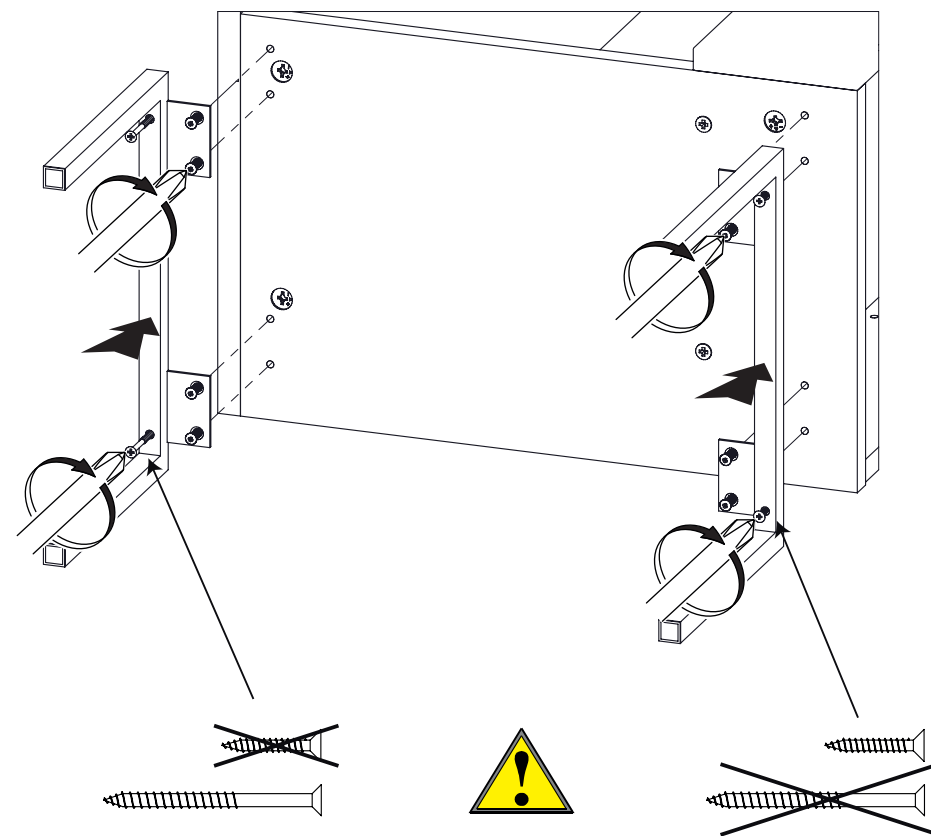
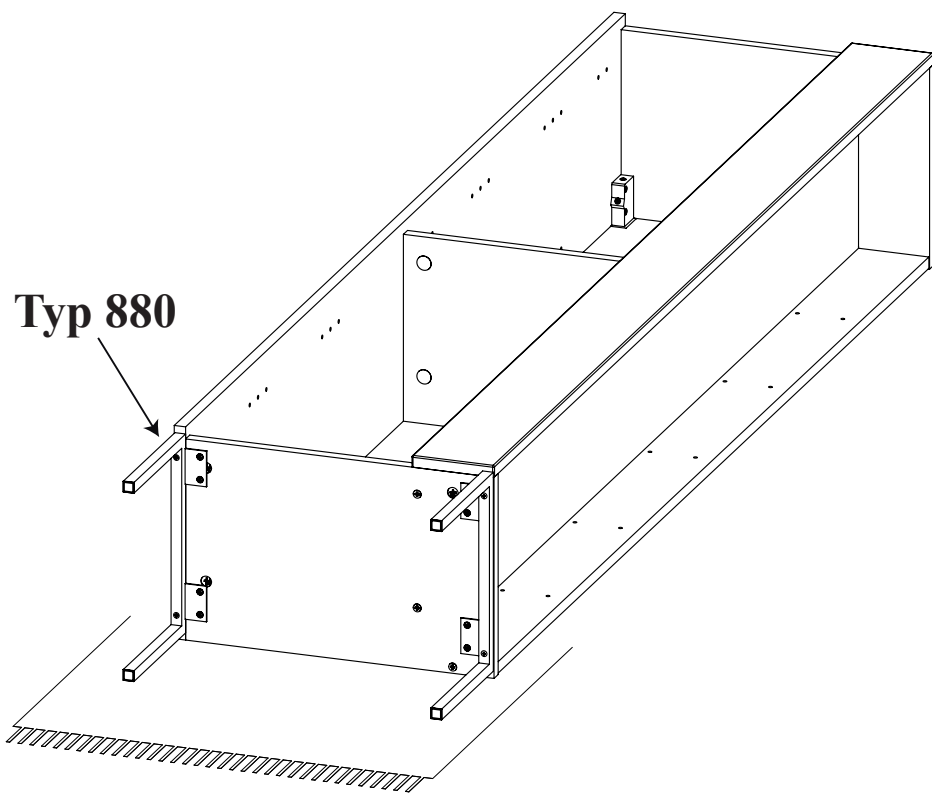

1R

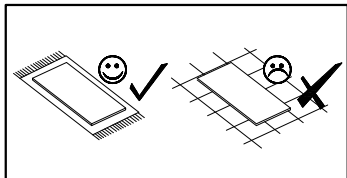
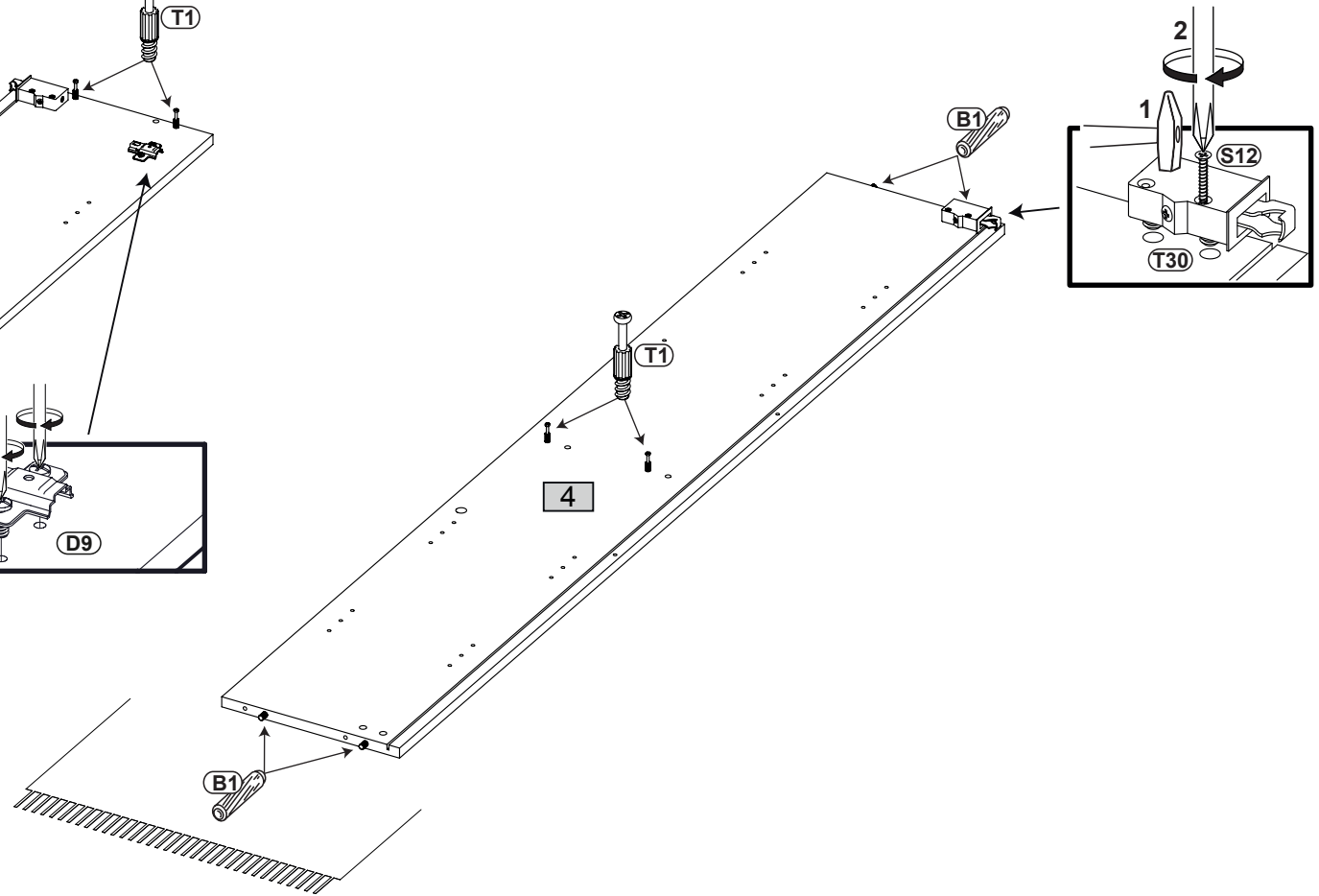
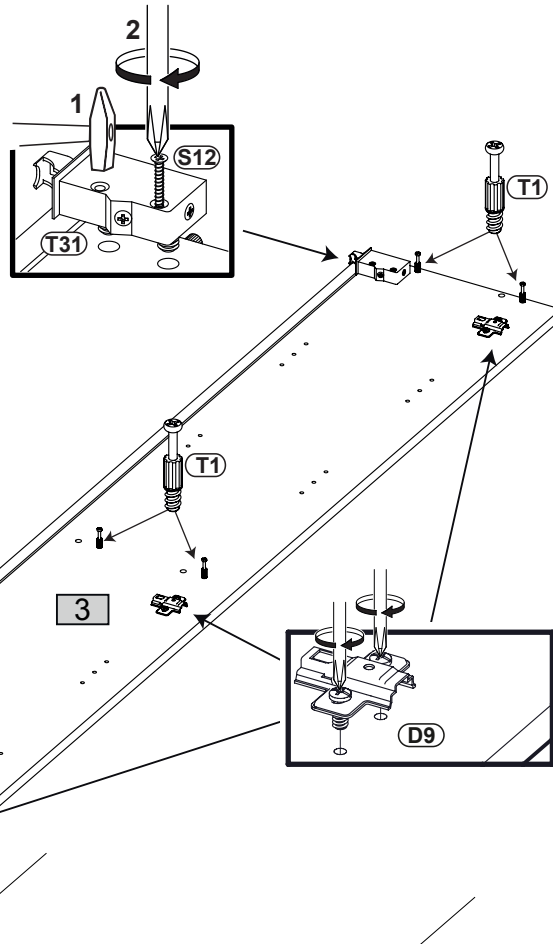
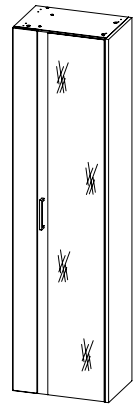
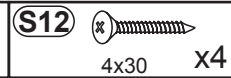
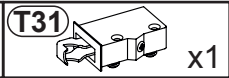
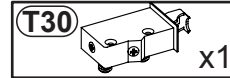
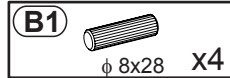
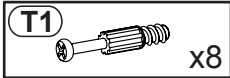

2

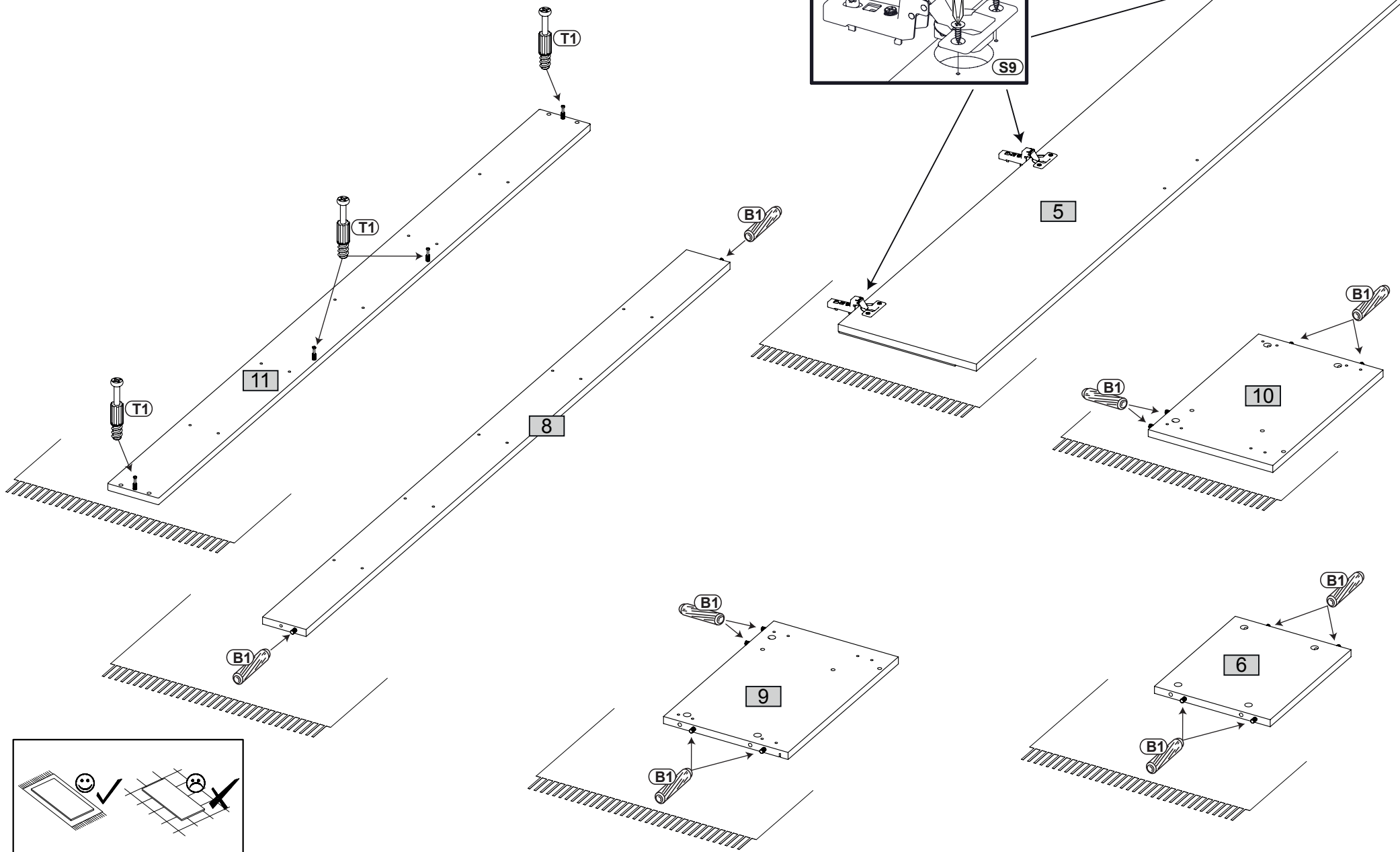
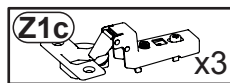
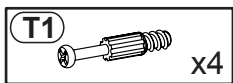
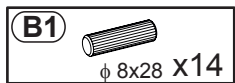

3R

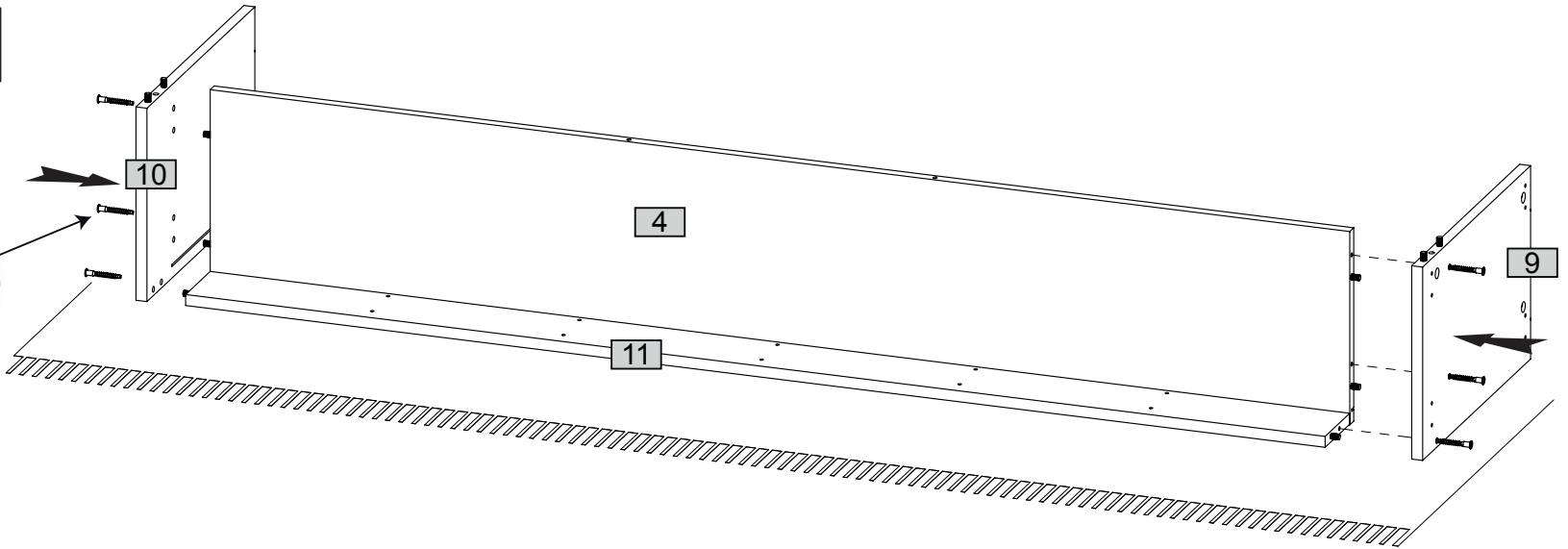
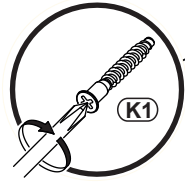
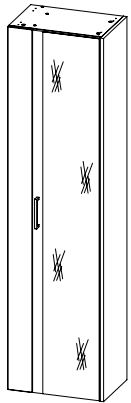
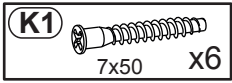

4R

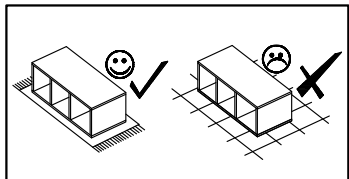
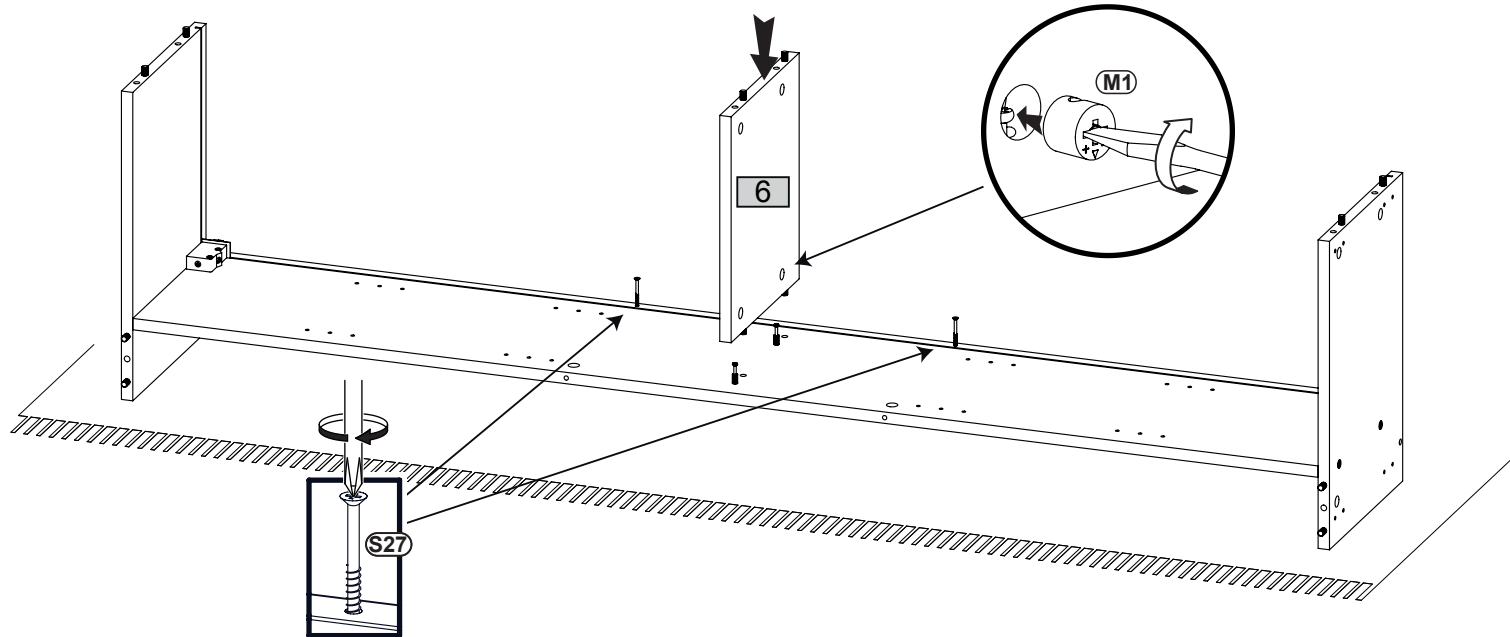
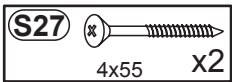

5R



x6

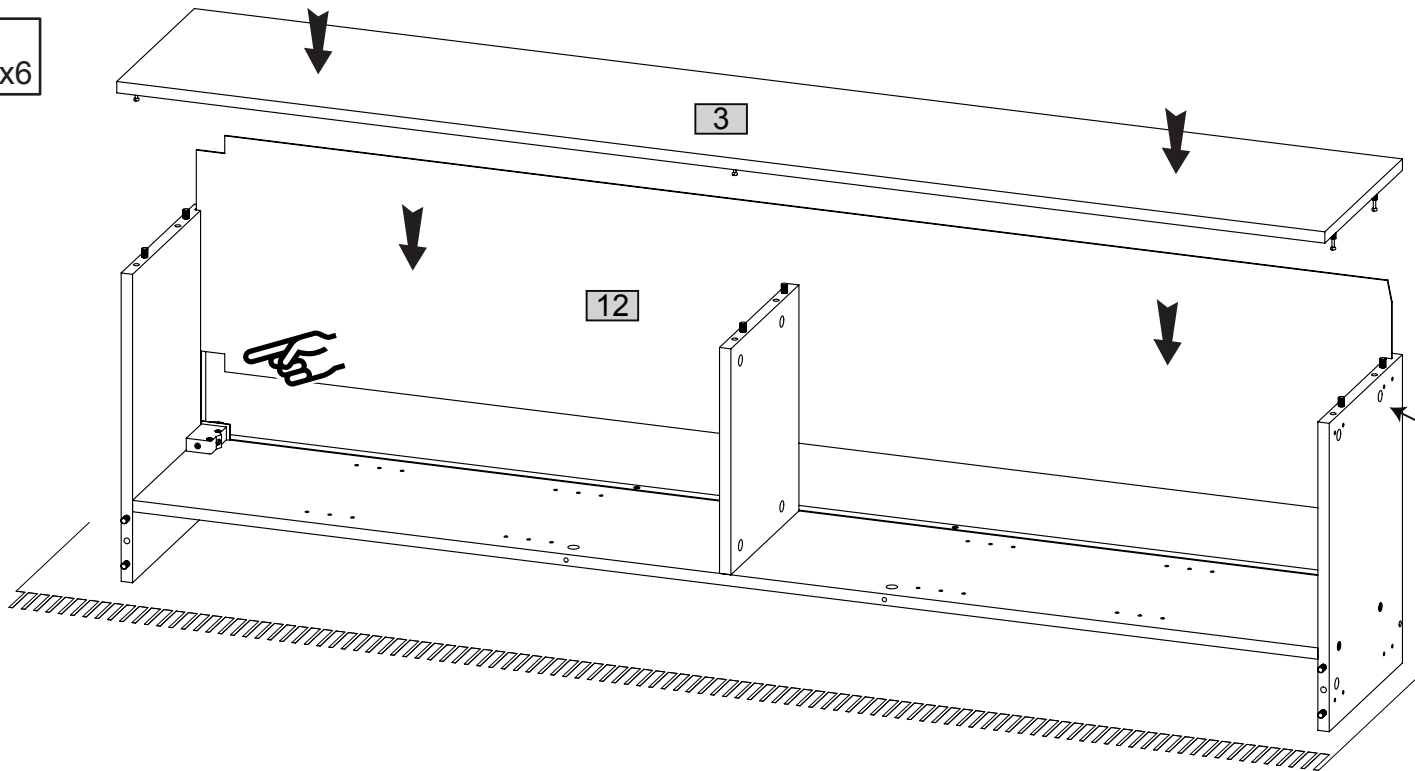

6R



x4

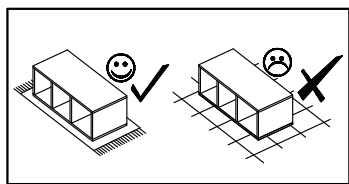
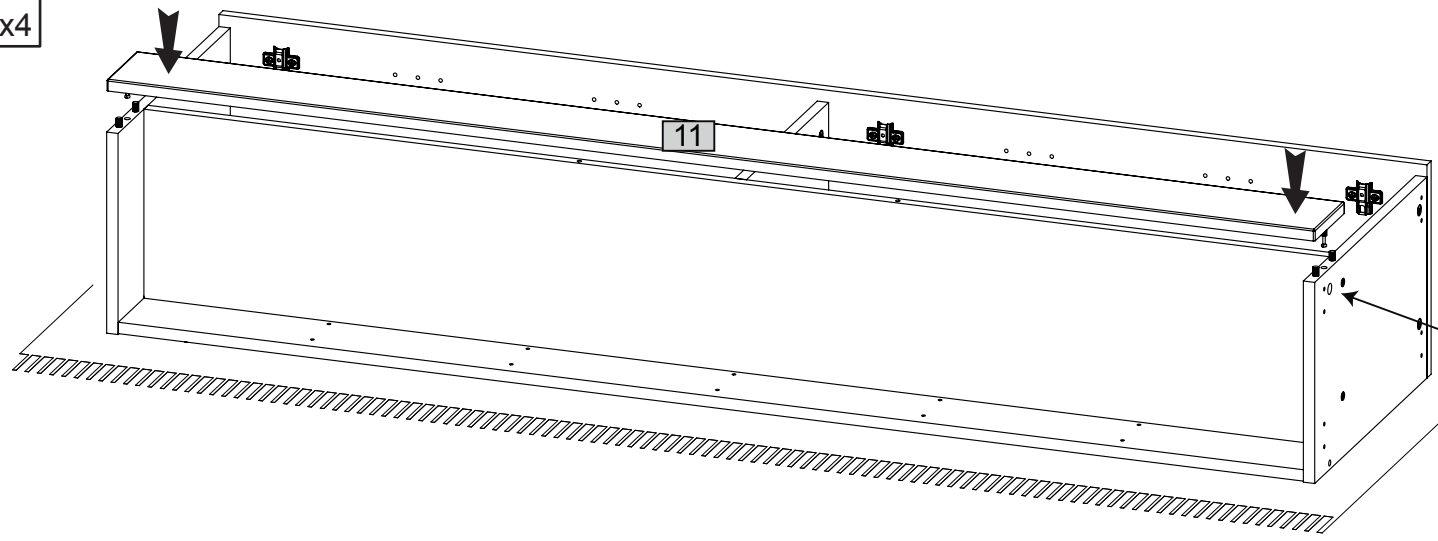

7R

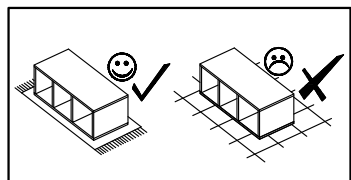
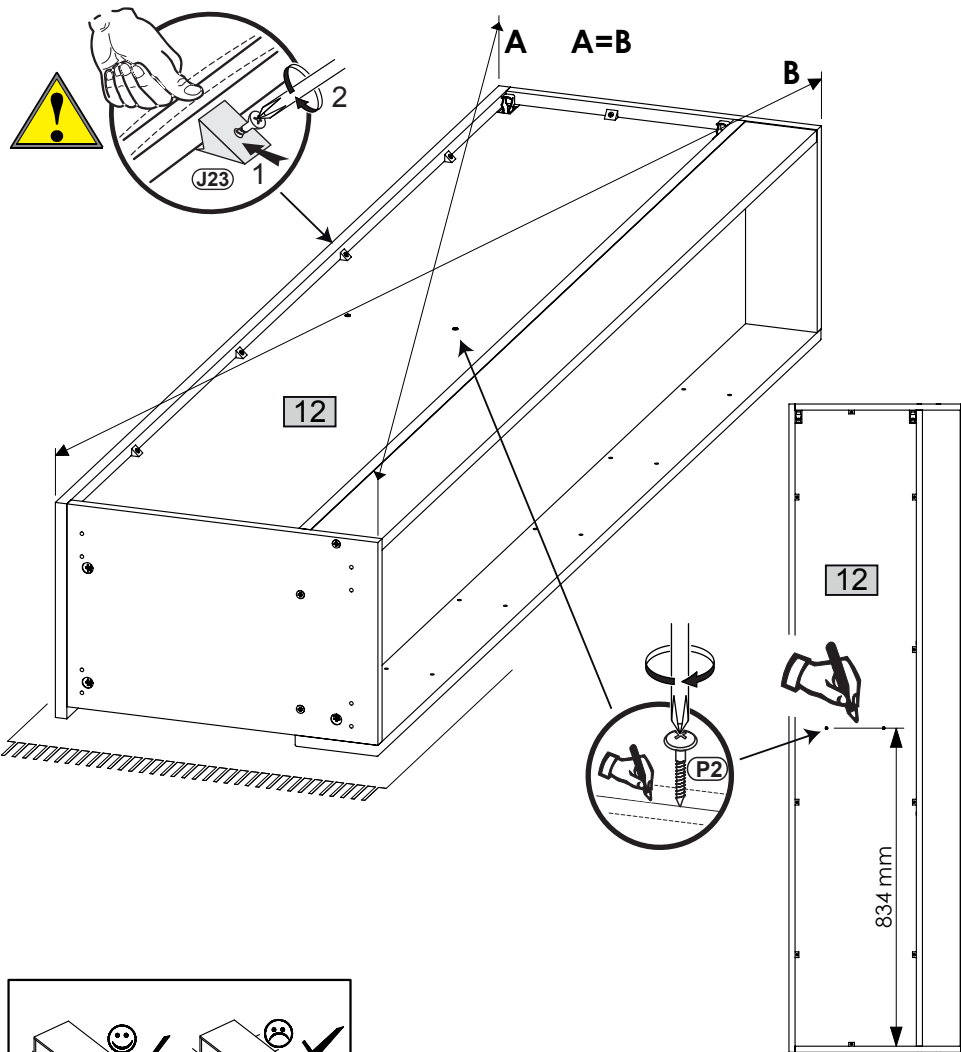
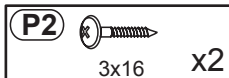
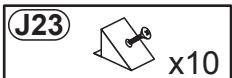

8R

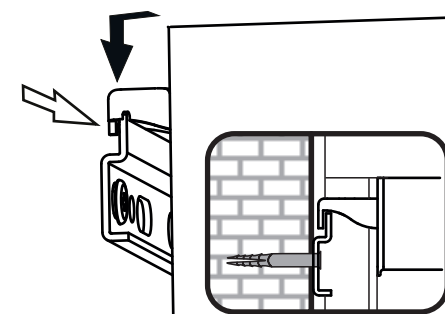
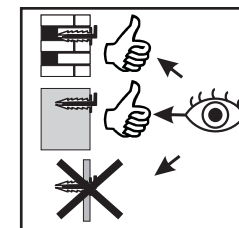
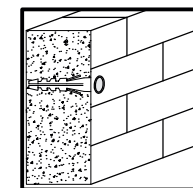
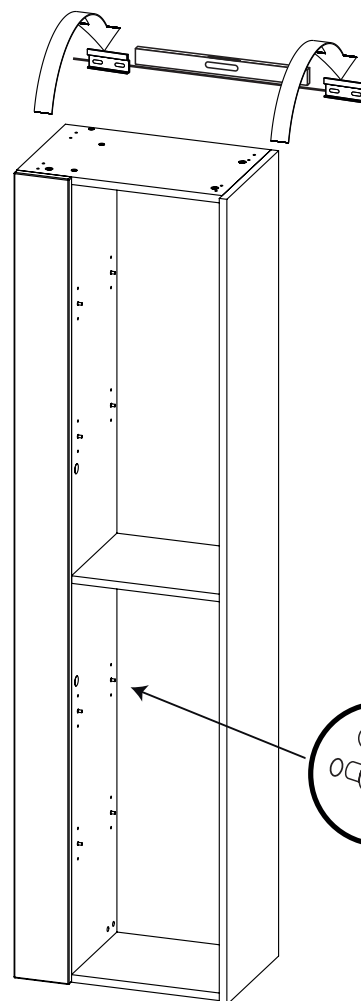
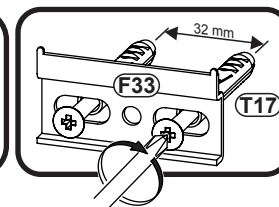
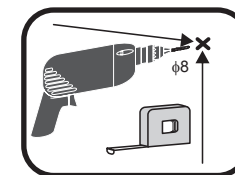
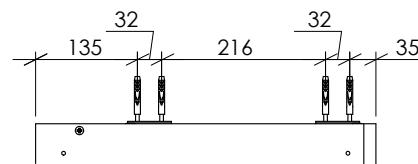
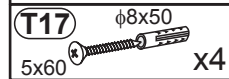
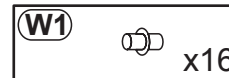
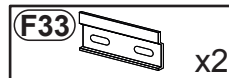

9R

