

- (PL) INSTRUKCJA MONTAŻOWA
- (D) MONTAGENLEITUNG
- (GB) ASSEMBLY INSTRUCTIONS
- (SK) NÁVOD NA MONTÁŽ
- (CZ) MONTÁŽNÍ NÁVOD

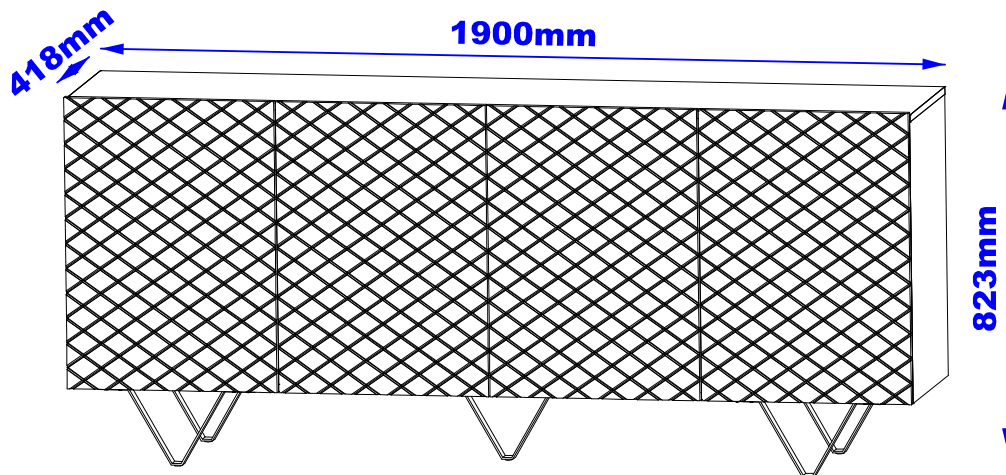

PL Szanowny Kliencie. Gdyby brakowało jakiejś części lub była by uszkodzona, to proszę oznaczyć część krzyżykiem na instrukcji montażowej i przesać instrukcję razem z reklamacją.

D Sehr geehrter Kunde. Sollte ein Teil fehlen oder beschädigt sein, kreuzen Sie bitte dieses deutlich auf der Montageanleitung an und schicken Sie zu uns ab.

GB Dear customer. Should there be any place missing or damaged, kindly mark this place clearly on the attached assembly instructions and return it to us.

SK Vážení zákazník, keby chýbala nejaká časť, alebo by bola poškodená, označte ju prosím krížikom na montážnom návode a zašlite návod spolu s reklamáciou.

CZ Vážení zákazník, kdyby chyběla nějaká část nebo byla poškozená, označte ji prosím křížkem na montážním návodu a zašlete návod spolu s reklamací.

Proszę montować mebel na kartonie!
Bitte das Möbel auf der Verpackung montieren!
Please assemble the piece of furniture on the cardboard!
Zložte prosím kus nábytku na kartón!
Sestavte prosím kus nábytku na kartón!

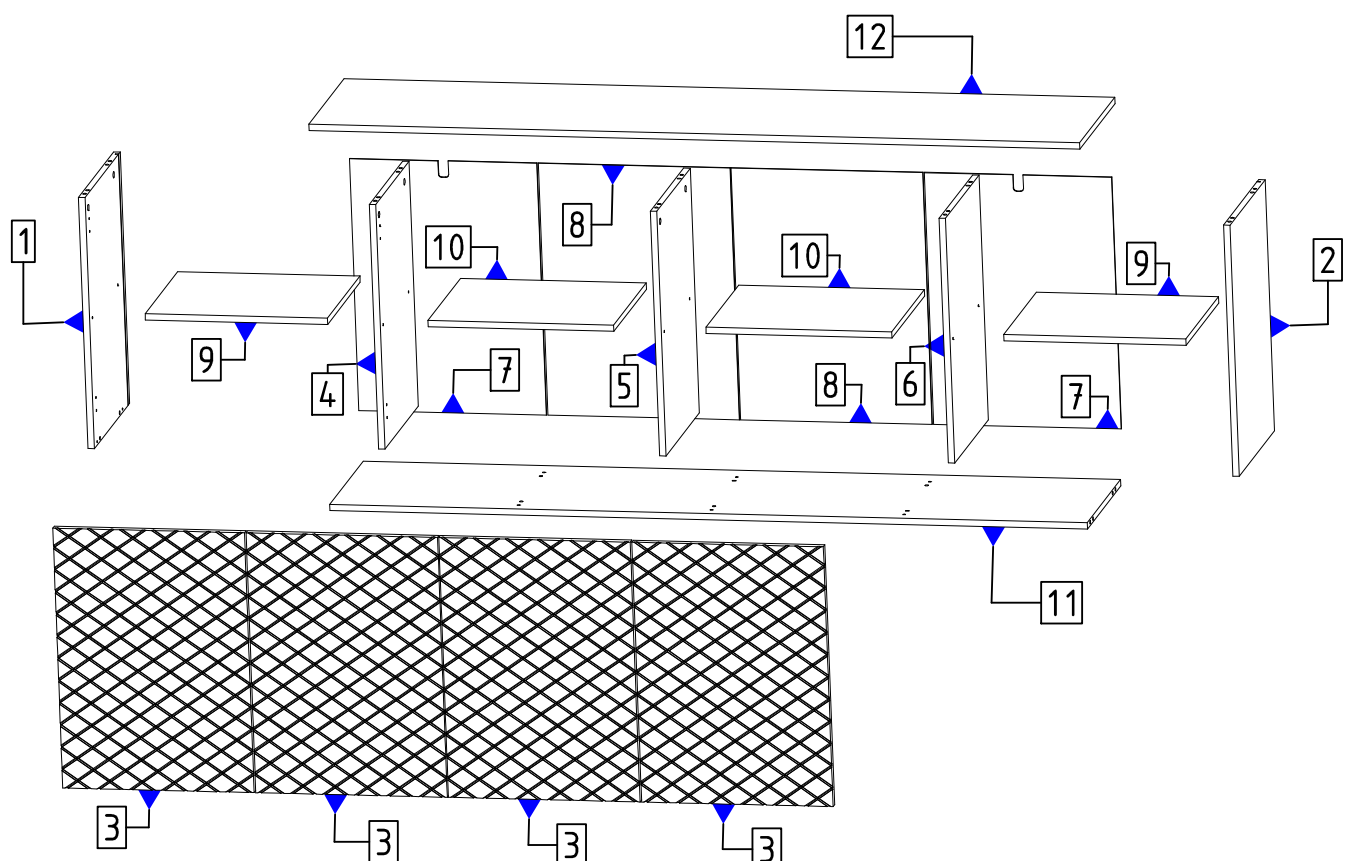
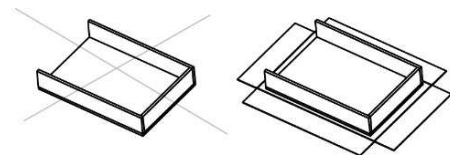
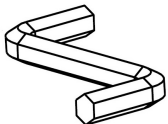
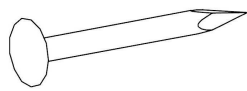
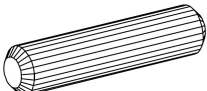
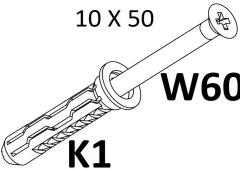
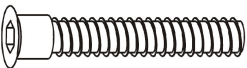
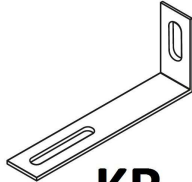

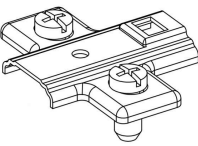
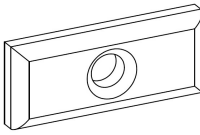
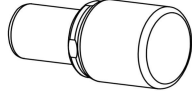
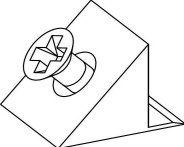
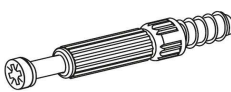
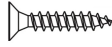
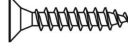

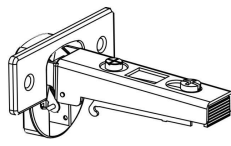
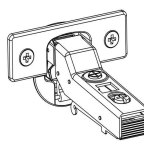
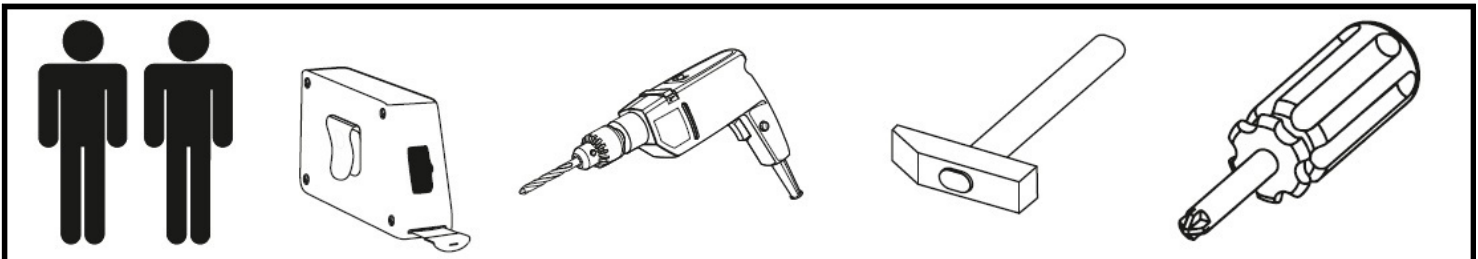

Table accessories

SCALIA KOMODA 190 4D

 <p>A1</p>	 <p>G</p>	<p>8 x 30</p>  <p>K</p>	<p>10 X 50</p>  <p>K1</p>	<p>6,3 X 50</p>  <p>KN</p>
 <p>KR</p>	<p>15 x 12</p>  <p>M</p>	 <p>PE</p>	 <p>PL</p>	 <p>PP3</p>
 <p>ST</p>	<p>6 x 34 mm</p>  <p>T</p>	<p>4 x 16</p>  <p>W16</p>	<p>3 x 16mm</p>  <p>W3</p>	 <p>Z</p>
 <p>ZPH</p>	 <p>ZPPH</p>			



Elements				Accessories	
SYMBOL	LENGTH	WIDTH	QUANTITY	SYMBOL	QUANTITY
BL [1]	400	628	1	A1	1
BP [2]	400	628	1	G	8
FT [3]	472	650	4	K	20
P1 [4]	380	612	1	K1	2
P2 [5]	612	380	1	KN	6
P3 [6]	380	612	1	KR	2
PC1 [7]	630	462	2	M	14
PC2 [8]	630	472	2	PE	8
PK1 [9]	370	449	2	PL	15
PK2 [10]	370	458	2	PP3	16
WD [11]	1867	380	1	ST	14
WG [12]	1900	400	1	T	14
				W16	20
				W3	15
				W60	2
				Z	14
				ZPH	4
				ZPPH	4

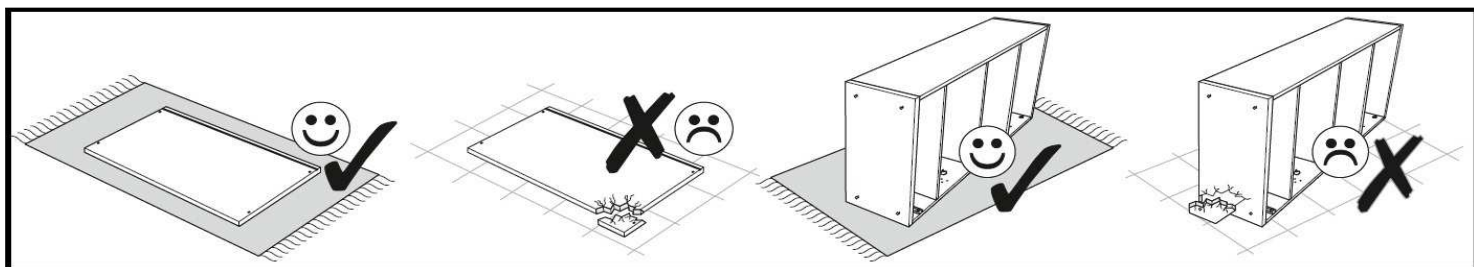

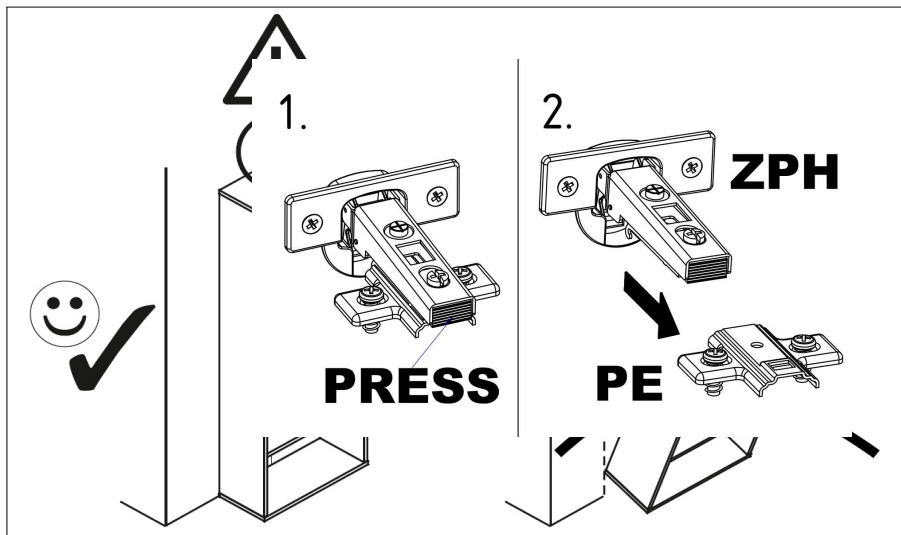

<p>PL UWAGA! Mebel trzeba trwale zamocować do ściany, aby uniknąć przewrócenia się mebla. W paczce są akcesoria przystosowane wyłącznie do ścian betonowych i z pełnej cegły. Jeśli nie jesteś pewien co do budowy ściany, skonsultuj się ze specjalistą.</p>	<p>EN ATTENTION! The furniture must be permanently attach to the wall, to avoid falling over furniture. There are accessories in the package adapted only to the walls concrete and solid brick. If you are not sure about the construction walls, consult expert.</p>	<p>IT NOTA! I mobili devono essere permanenti attaccare al muro, per evitare di cadere mobili. Ci sono accessori nel pacchetto adattato solo alle pareti mattone concreto e solido. se non sei sicuro della costruzione muri, consultare specialista.</p>
<p>D ACHTUNG! Die Möbel müssen dauerhaft sein an der Wand befestigen, um nicht umzufallen Möbel. Es gibt Zubehör in der Verpackung nur an die Wände angepasst Beton und Vollziegel. wenn Sie sind sich nicht sicher über die Konstruktion Wände konsultieren Spezialist.</p>	<p>ES NOTA! La pieza necesita ser permanentemente pegar a la pared, para evitar caerse muebles. Están en el paquete accesorios adaptados solo para paredes Hormigón y ladrillo macizo. si no estás seguro de la construcción Paredes, consultar a un especialista.</p>	<p>FR REMARQUE! La pièce doit être en permanence attacher au mur, pour éviter de tomber meubles. Ils sont dans le paquet accessoires adaptés seulement pour les murs béton et brique pleine. si vous n'êtes pas sûr de la construction murs, consultez un spécialiste.</p>
<p>CZ POZOR! Kus musí být natrvalo připevnit ke zdi, aby se zabránilo pádu nábytek. Jsou v balení příslušenství přizpůsobené pouze pro stěny betonové a pevné cihly. pokud Nejste si jisti stavbou konzultovat odborníka.</p>	<p>SLO POZOR! Kus musí byť natrvalo pripojit' k stene, aby sa zabránilo pádu nábytok. Sú v balení príslušenstvo prispôsobené len pre steny betón a pevné tehly. ak Nie ste si istý stavbou konzultujte s odborníkom.</p>	

1.

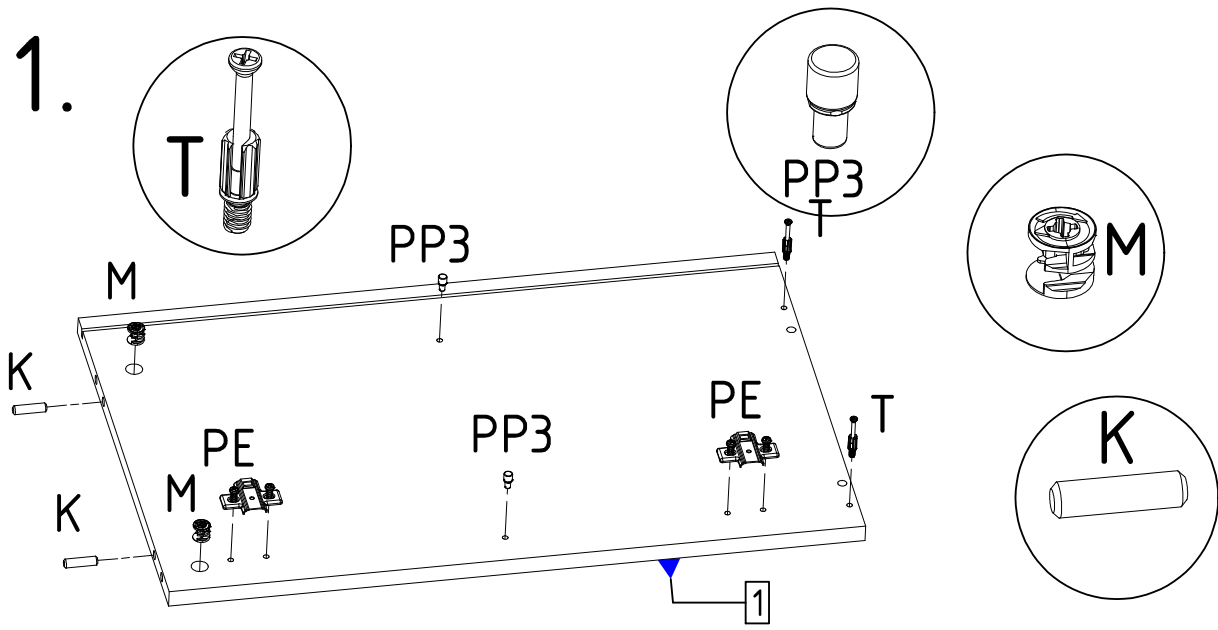

2.

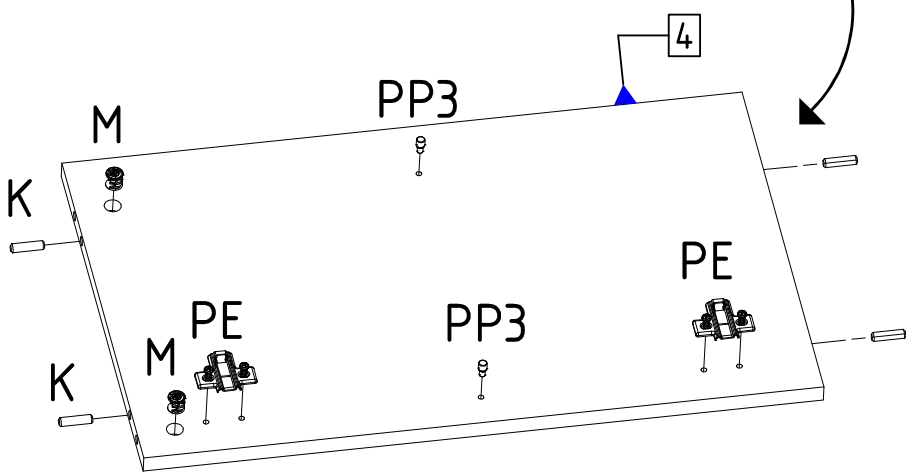
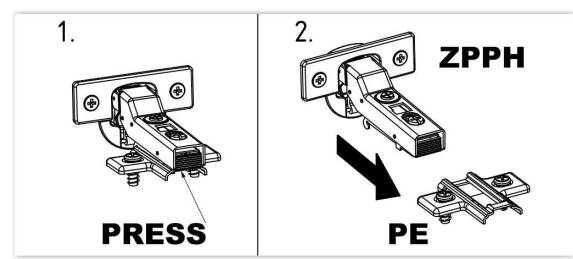
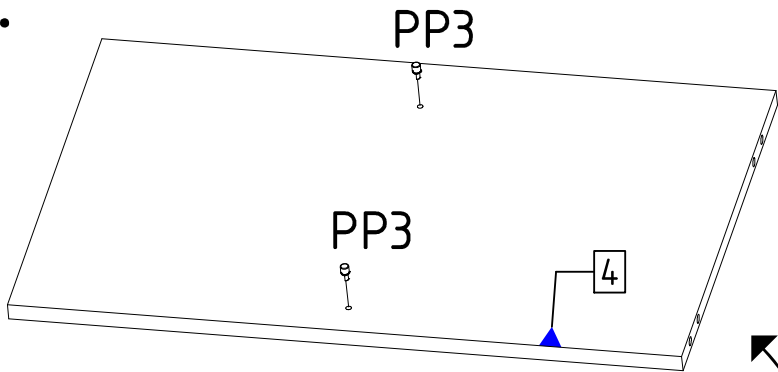
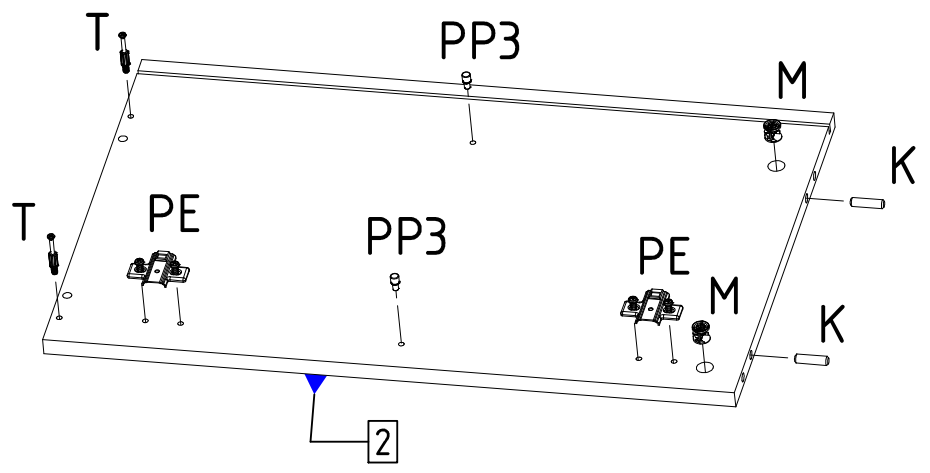
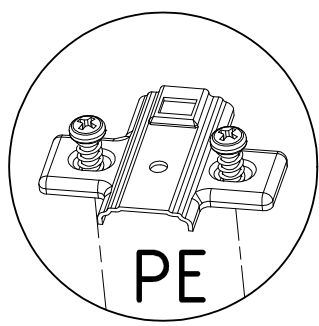

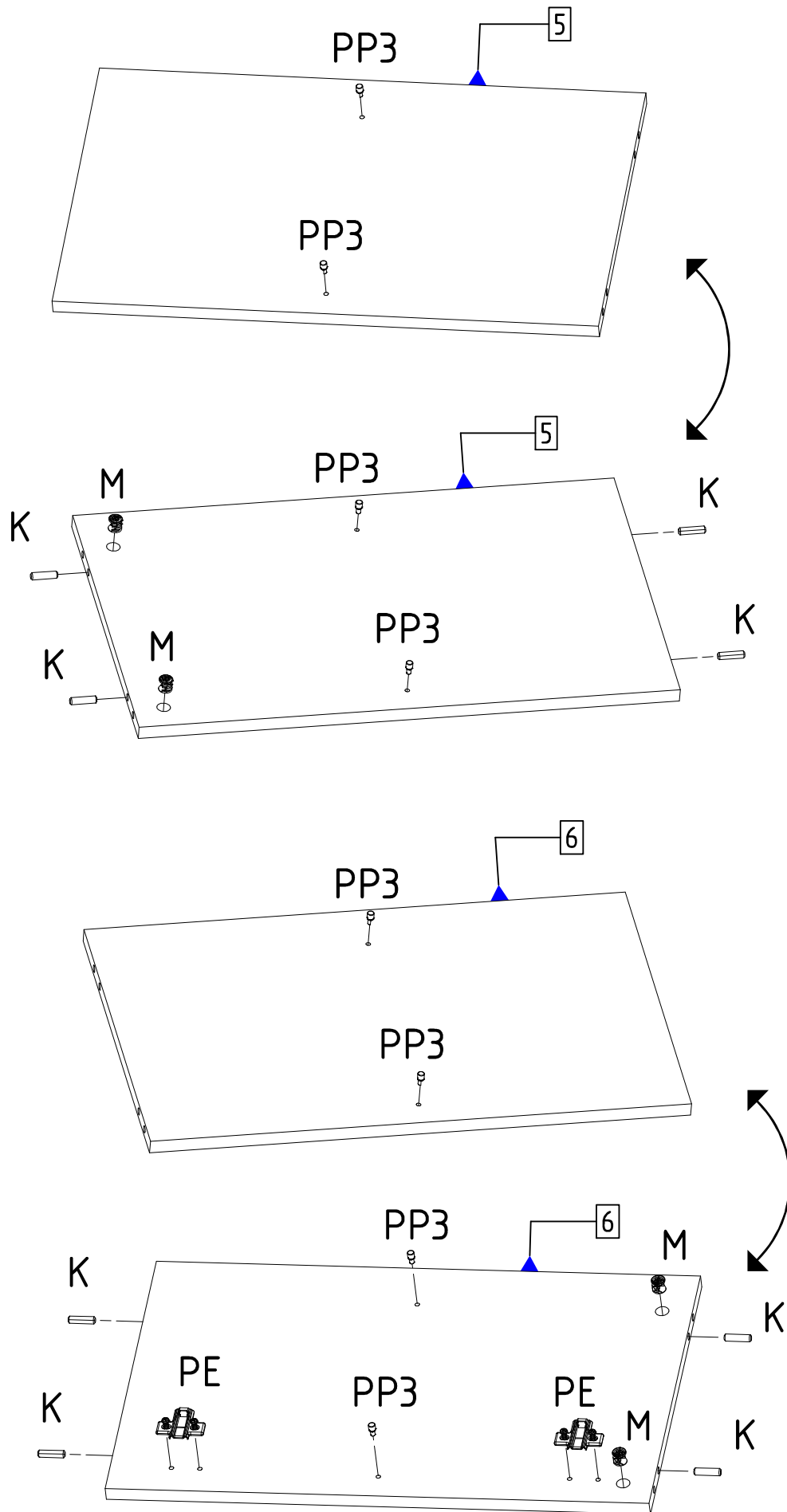

9.

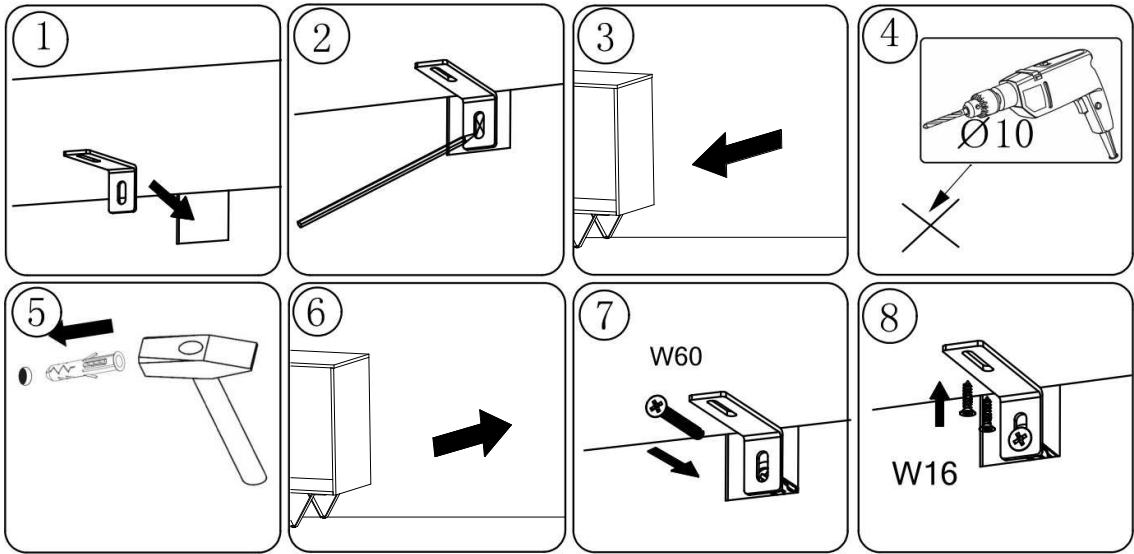
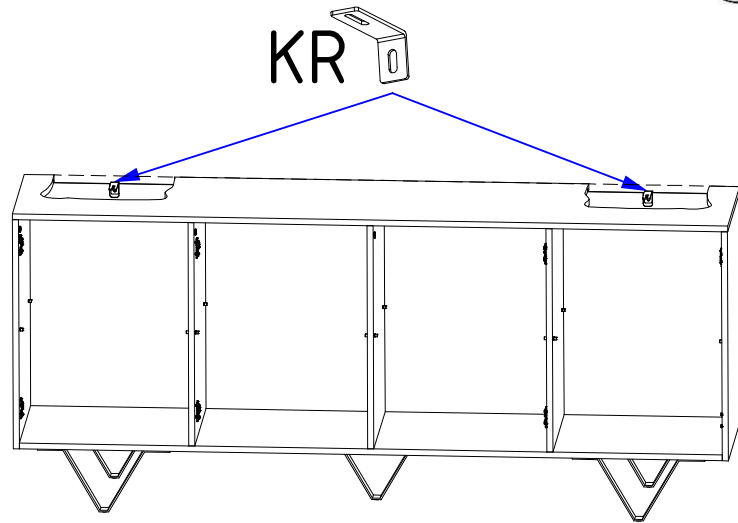

10.

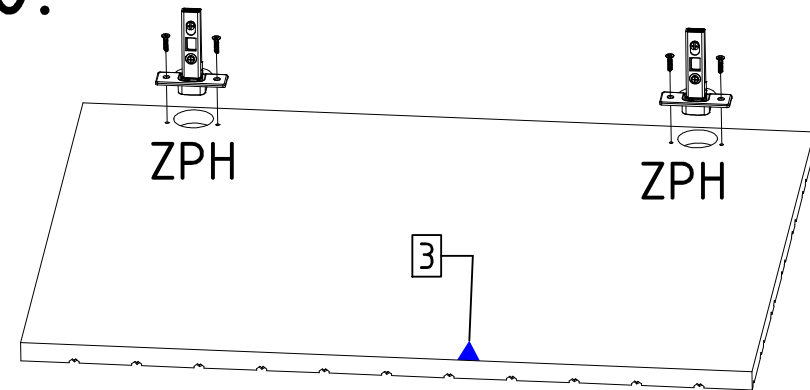

x2

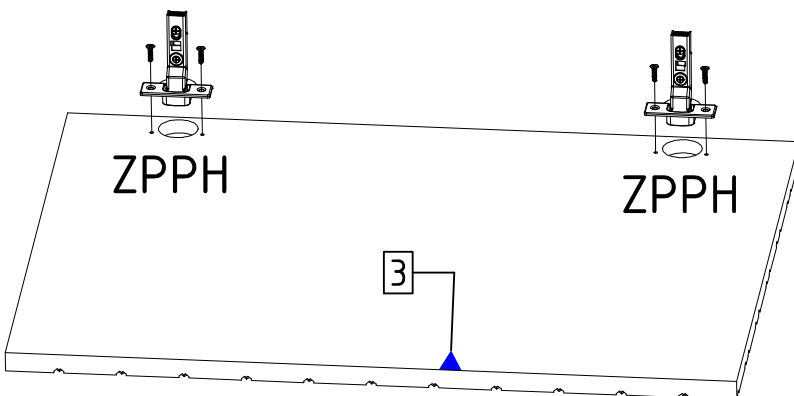
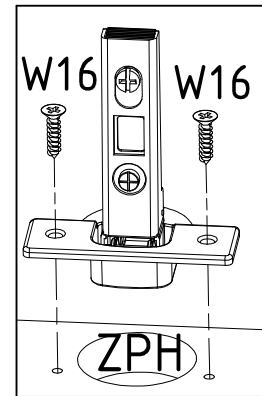

x2

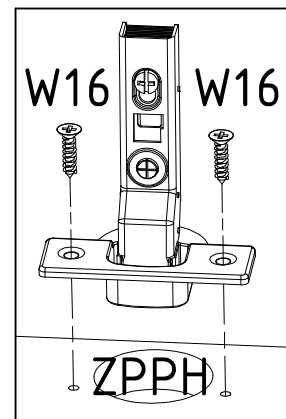

11.

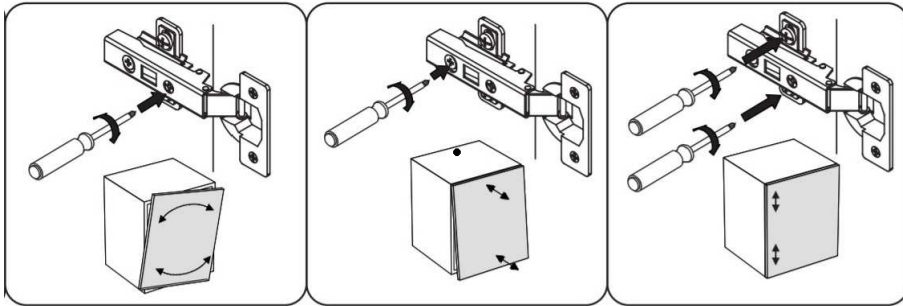
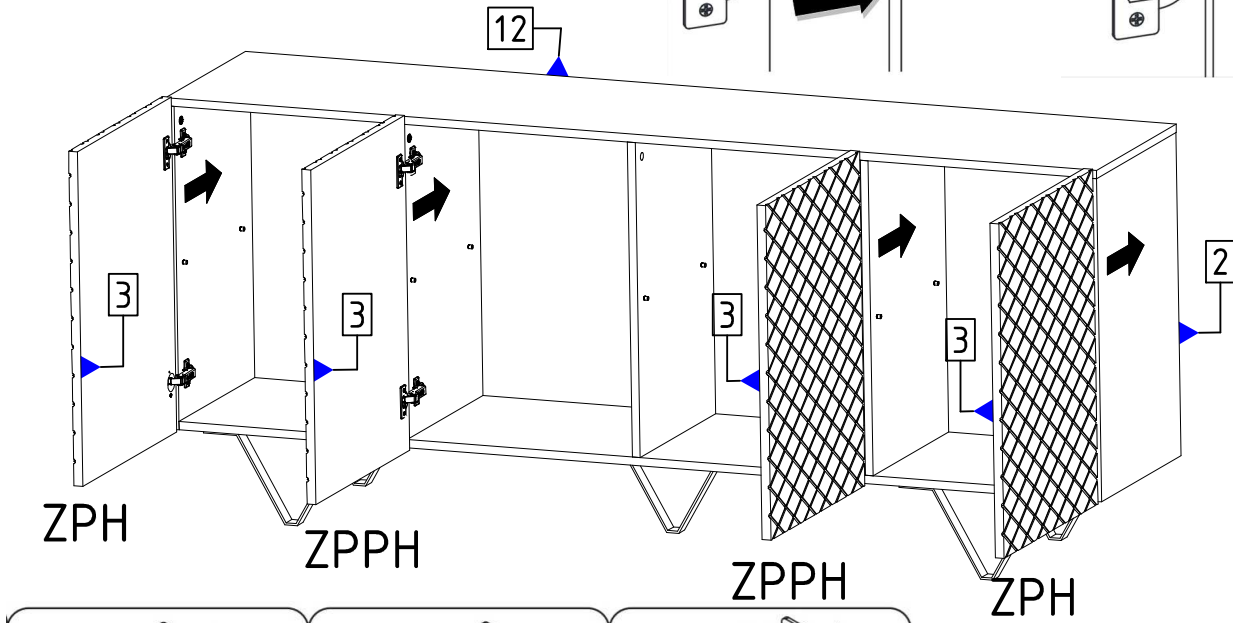
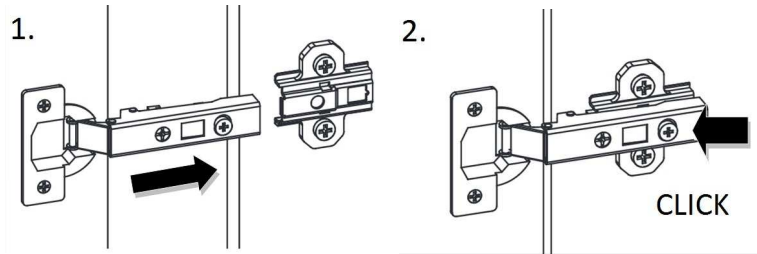

12.

